









Box Size:

92.5" x 39.25" x 11.25"

Weight:

41.8 lbs.





























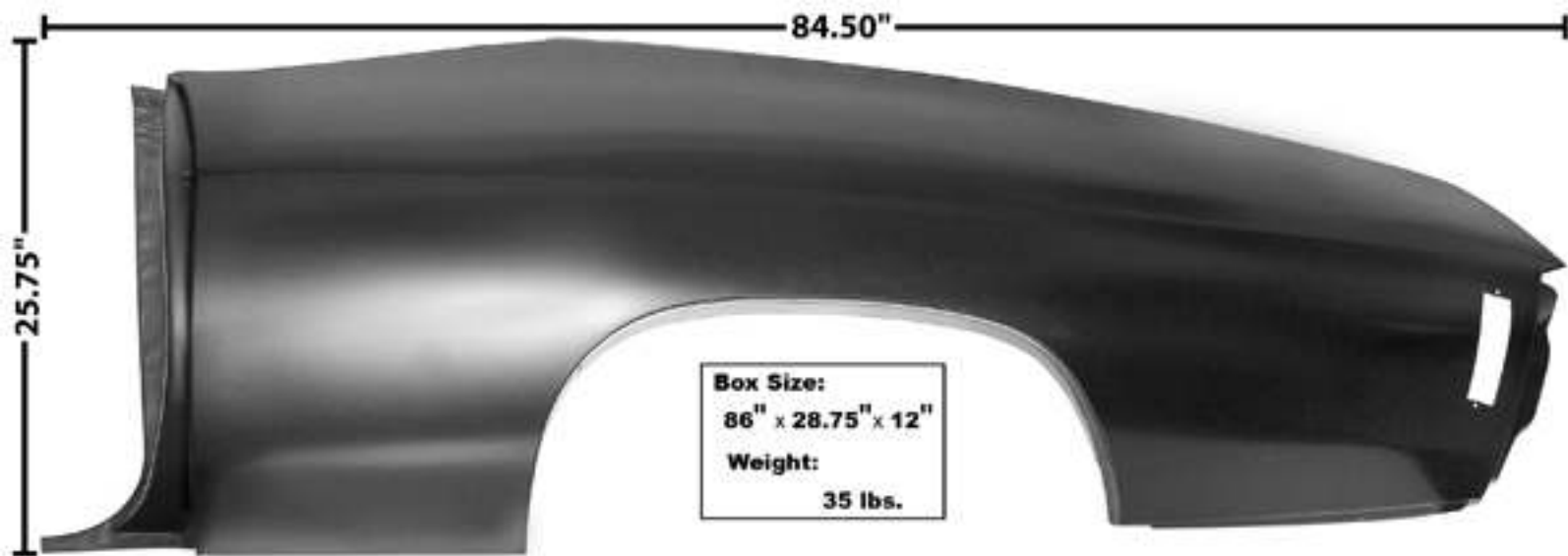

84.50"

25.75"

Box Size:

86" x 28.75" x 12"

Weight:

35 lbs.



84.50"

25.75"

Box Size:

86" x 28.75" x 12"

Weight:

35 lbs.

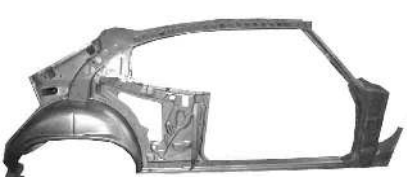





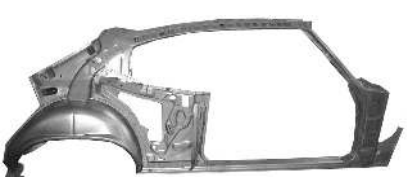





117.50"

43.75"



Back View

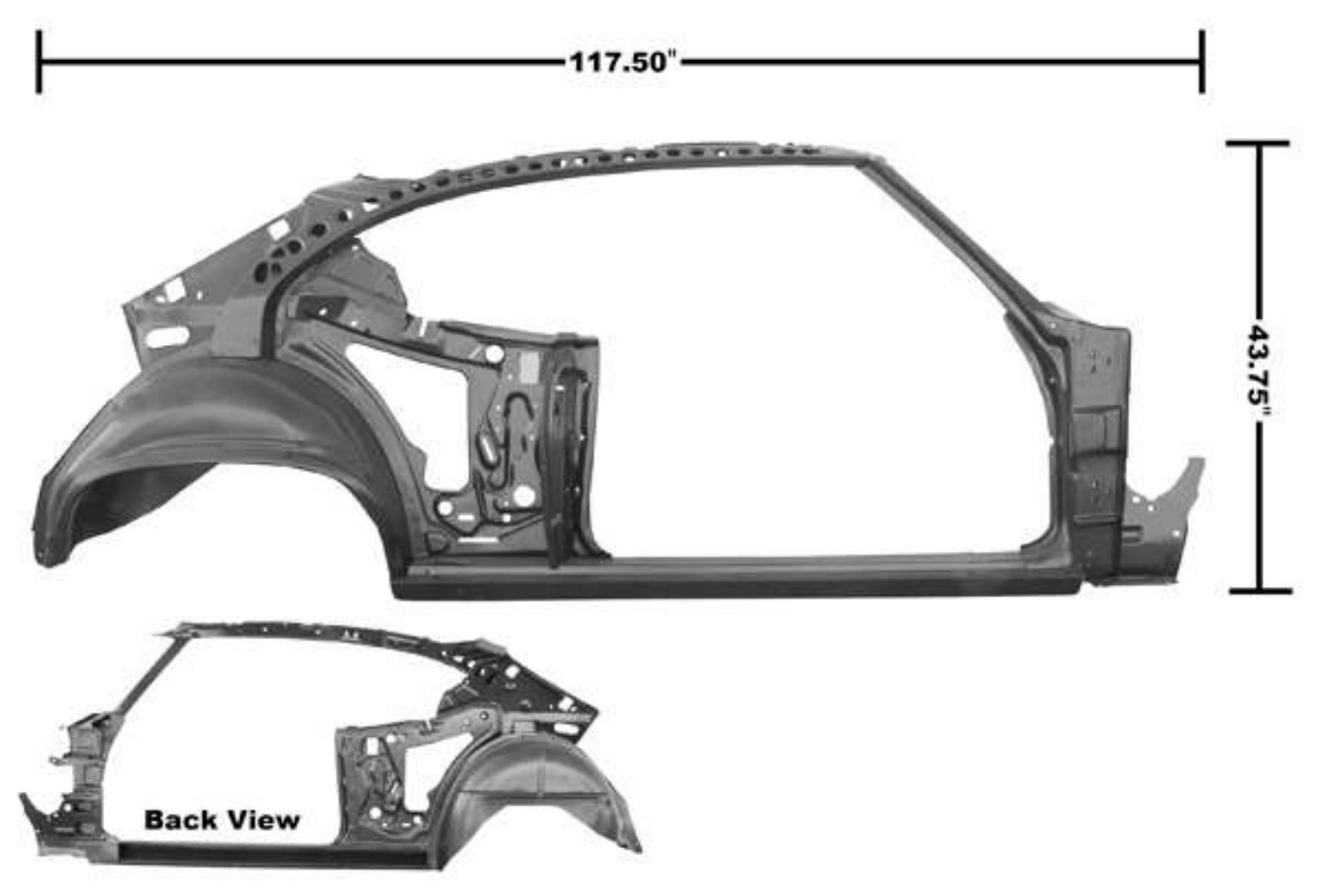

117.50"

43.75"

Back View







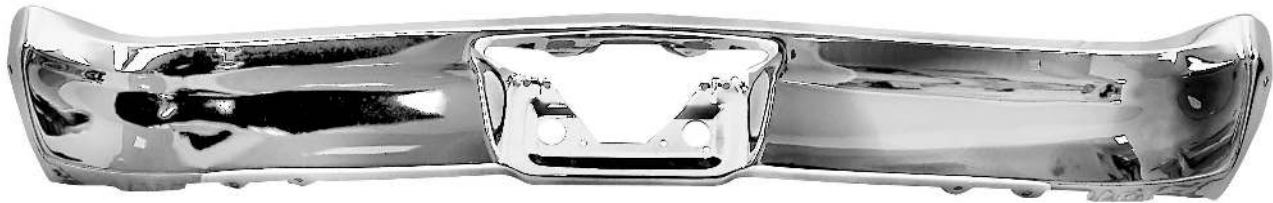



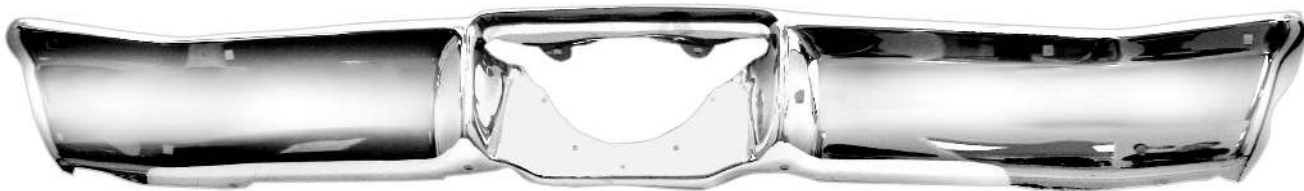































































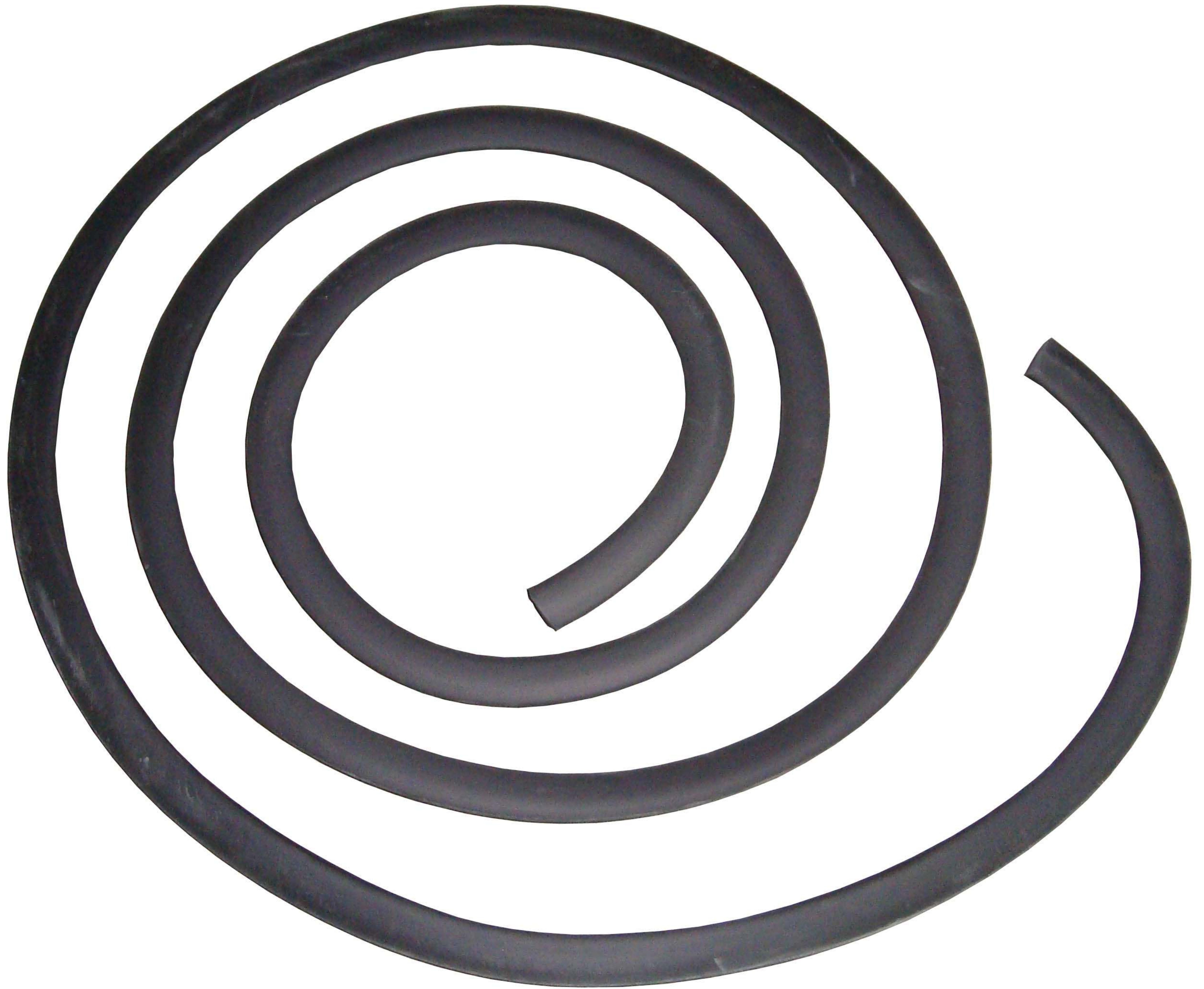















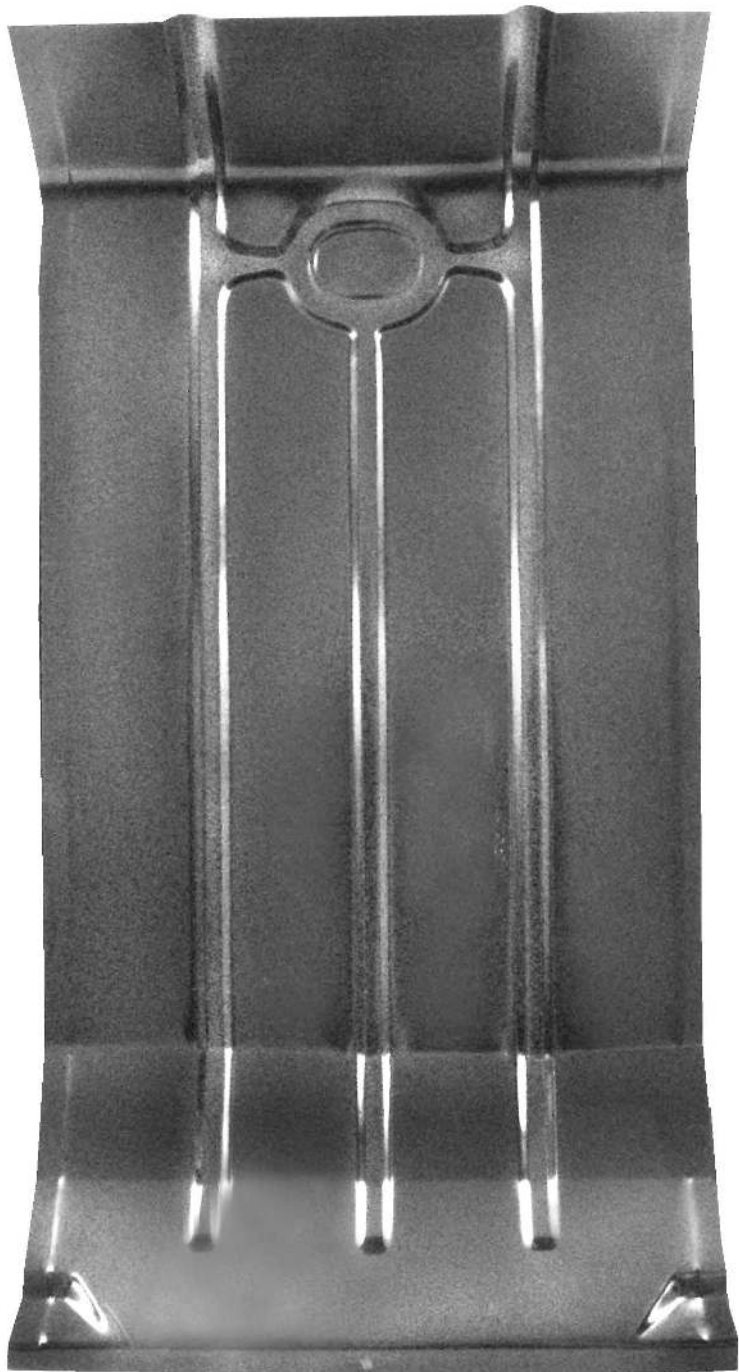

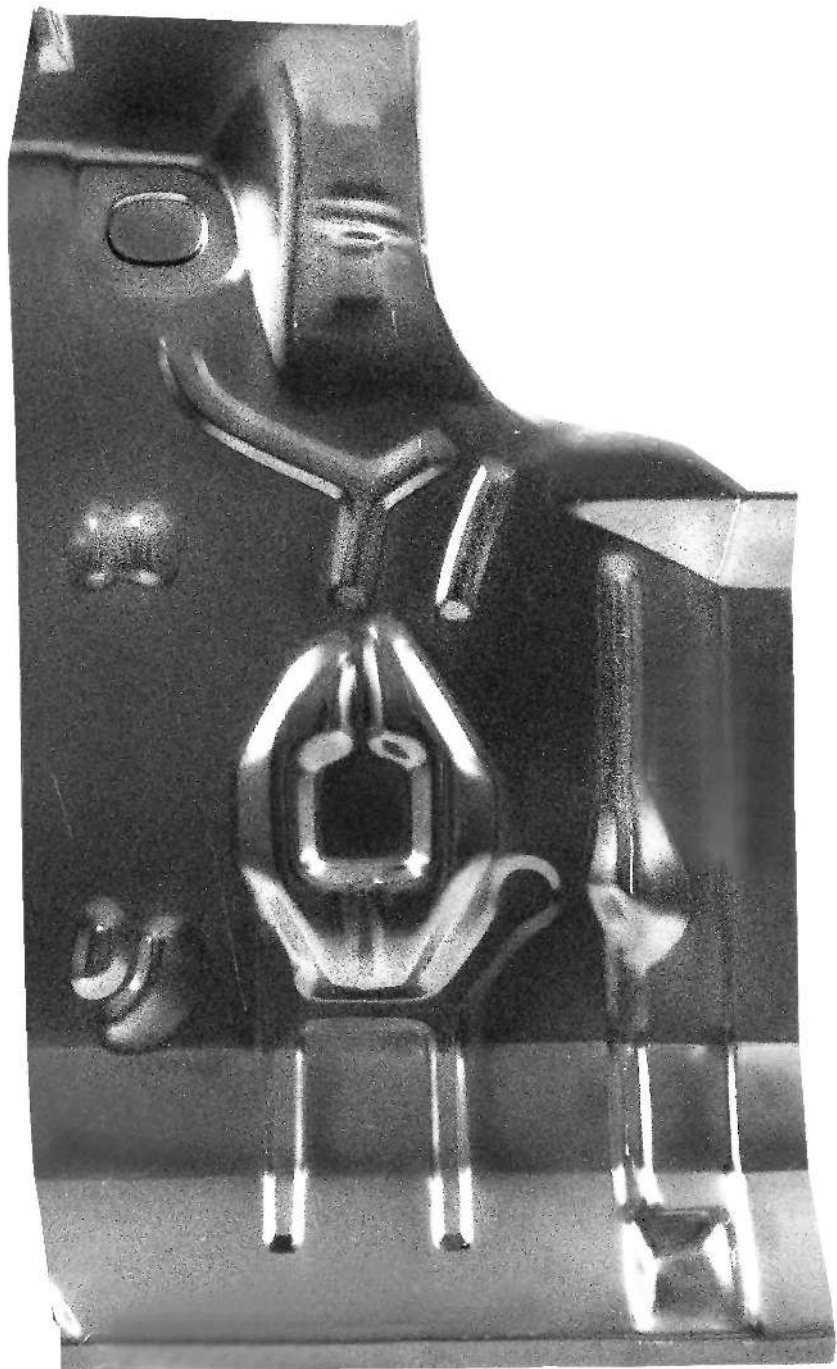

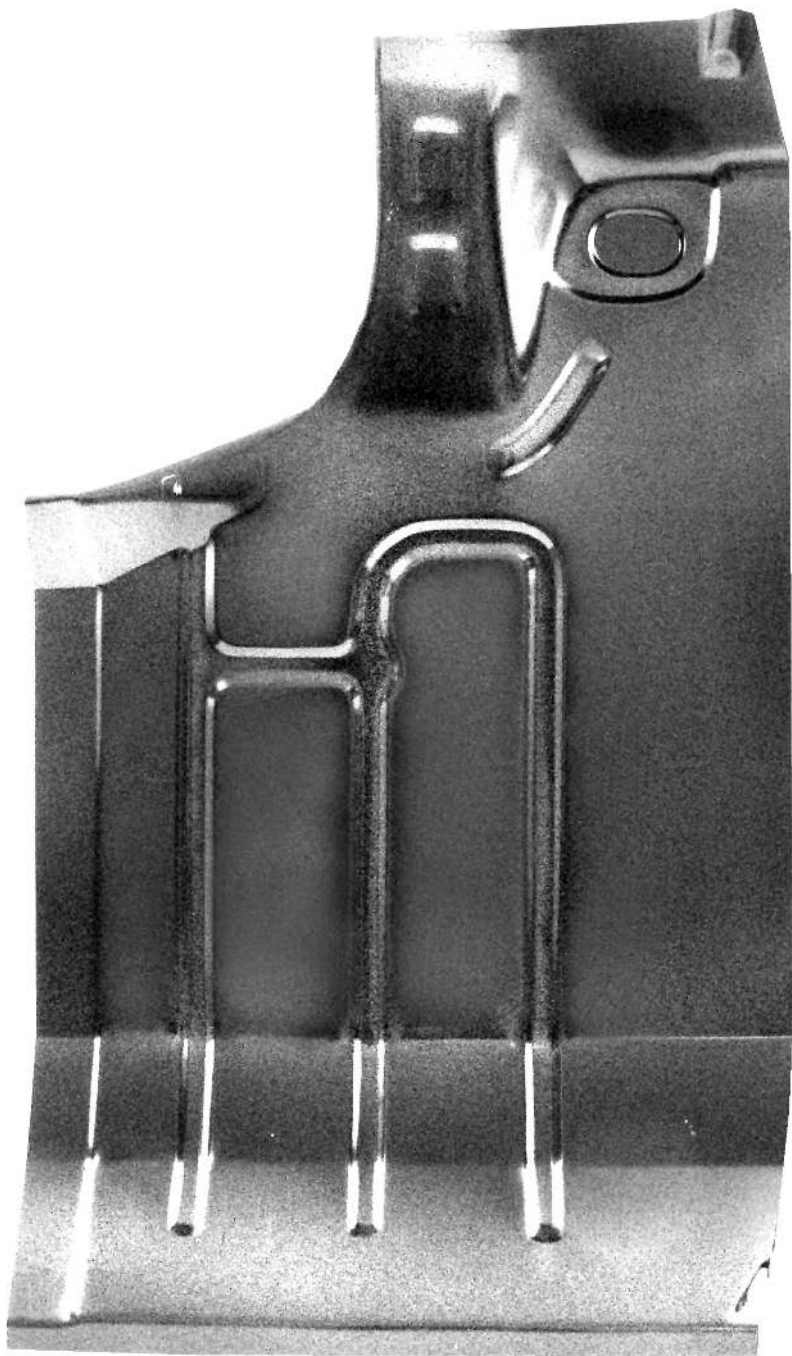







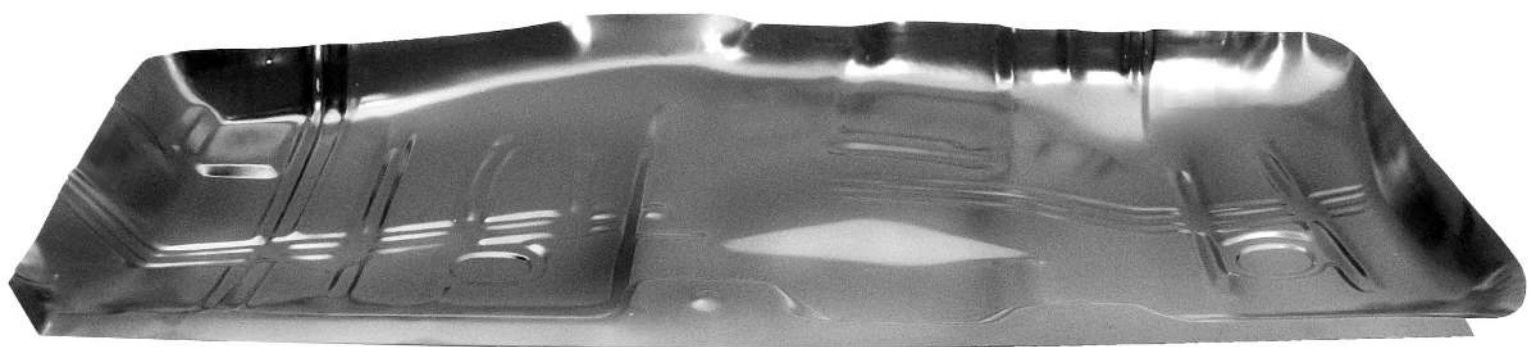

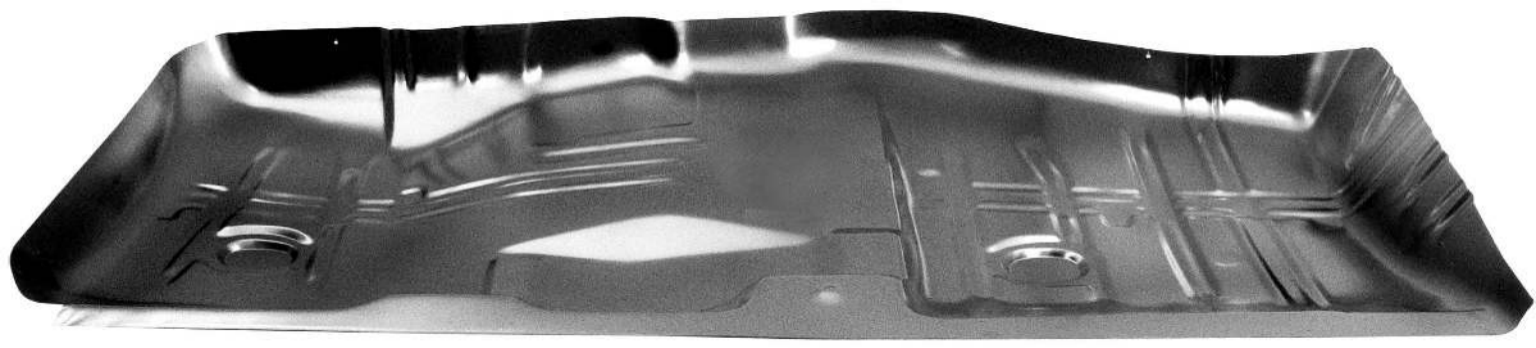

























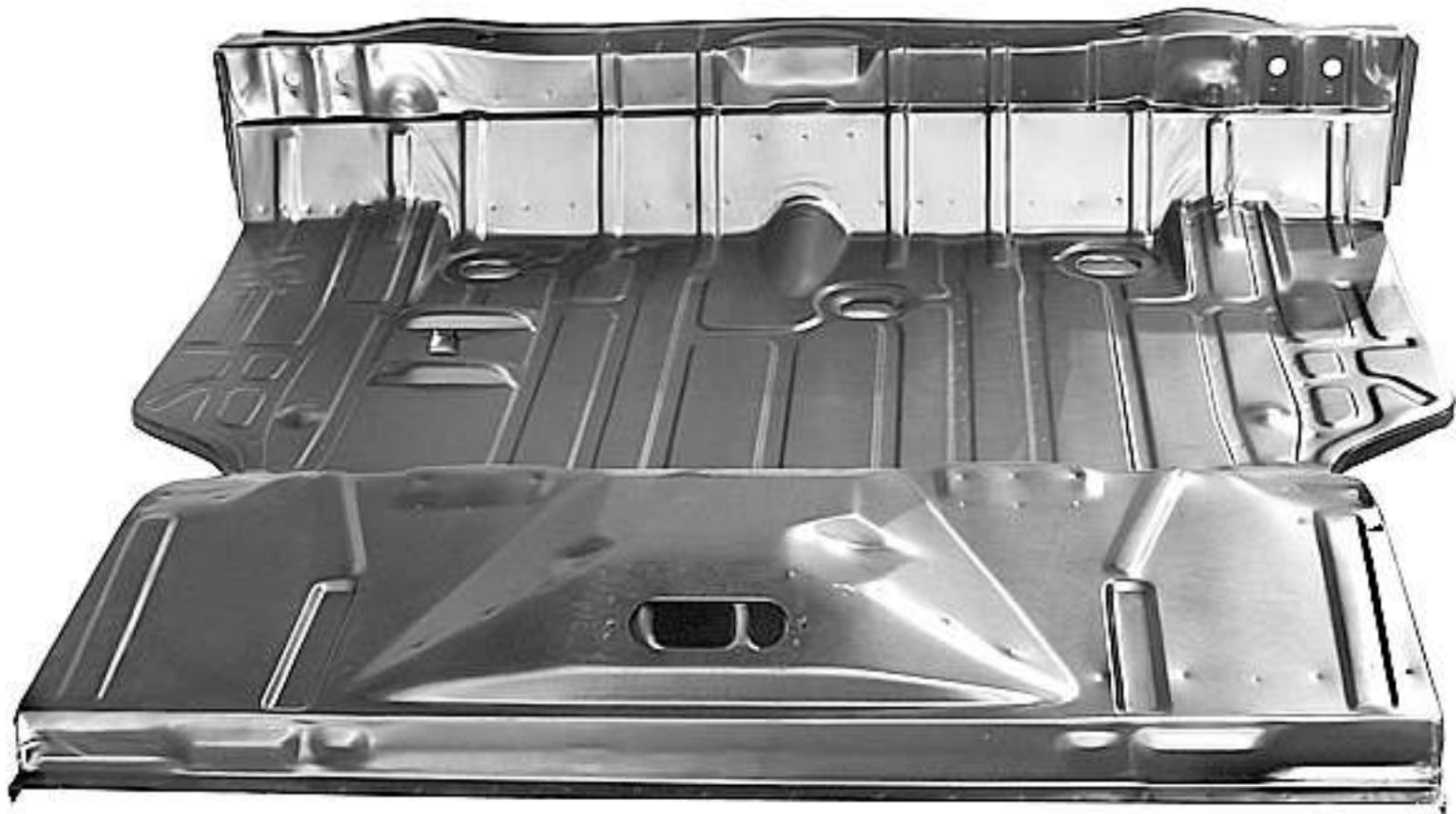



















Back View











































































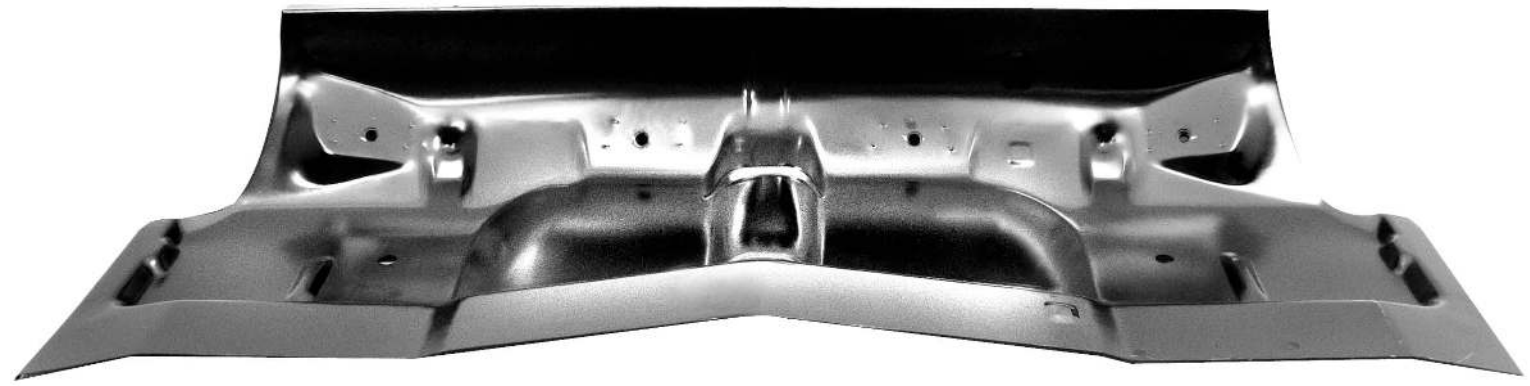

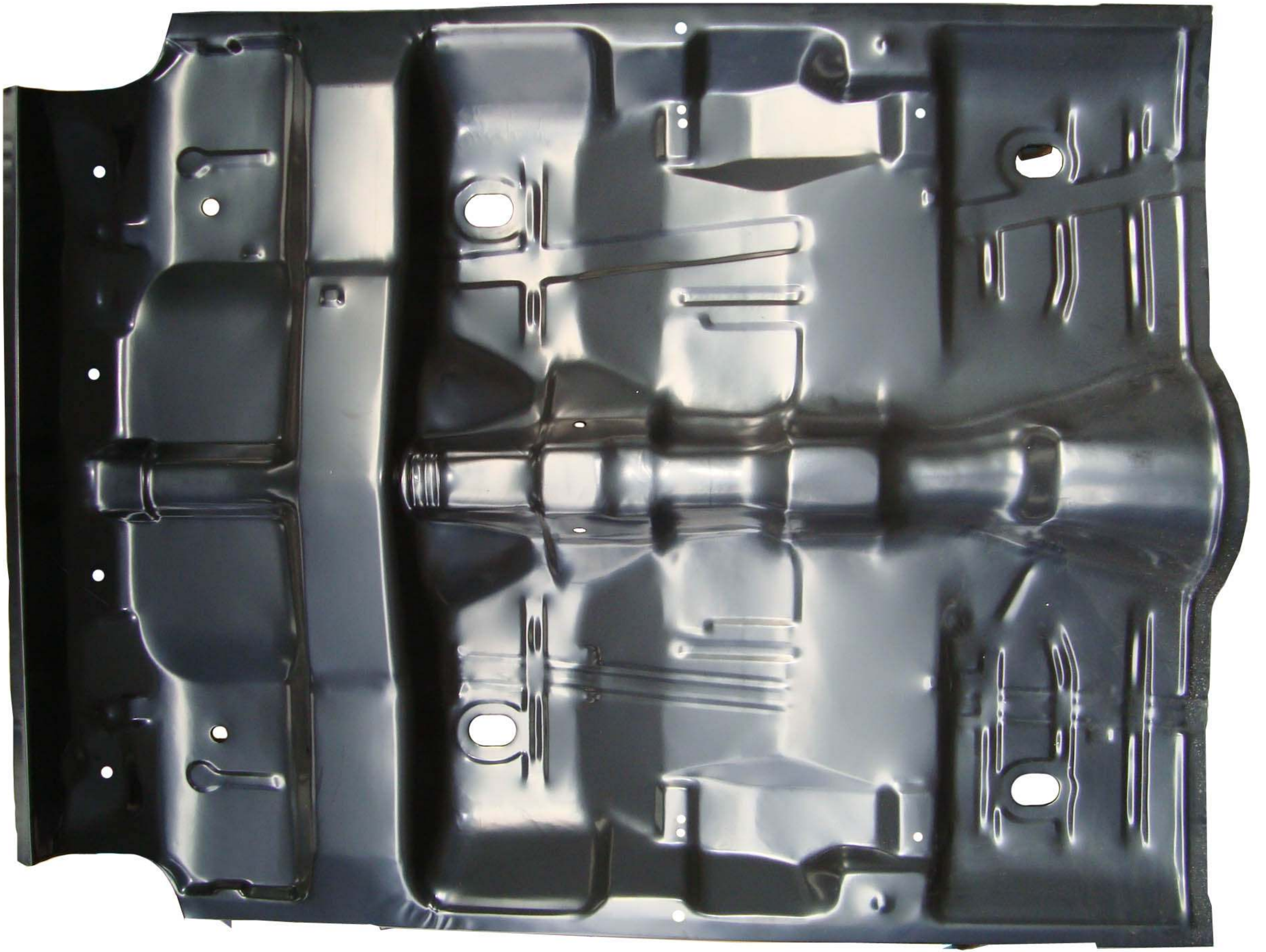







Back View





Back View

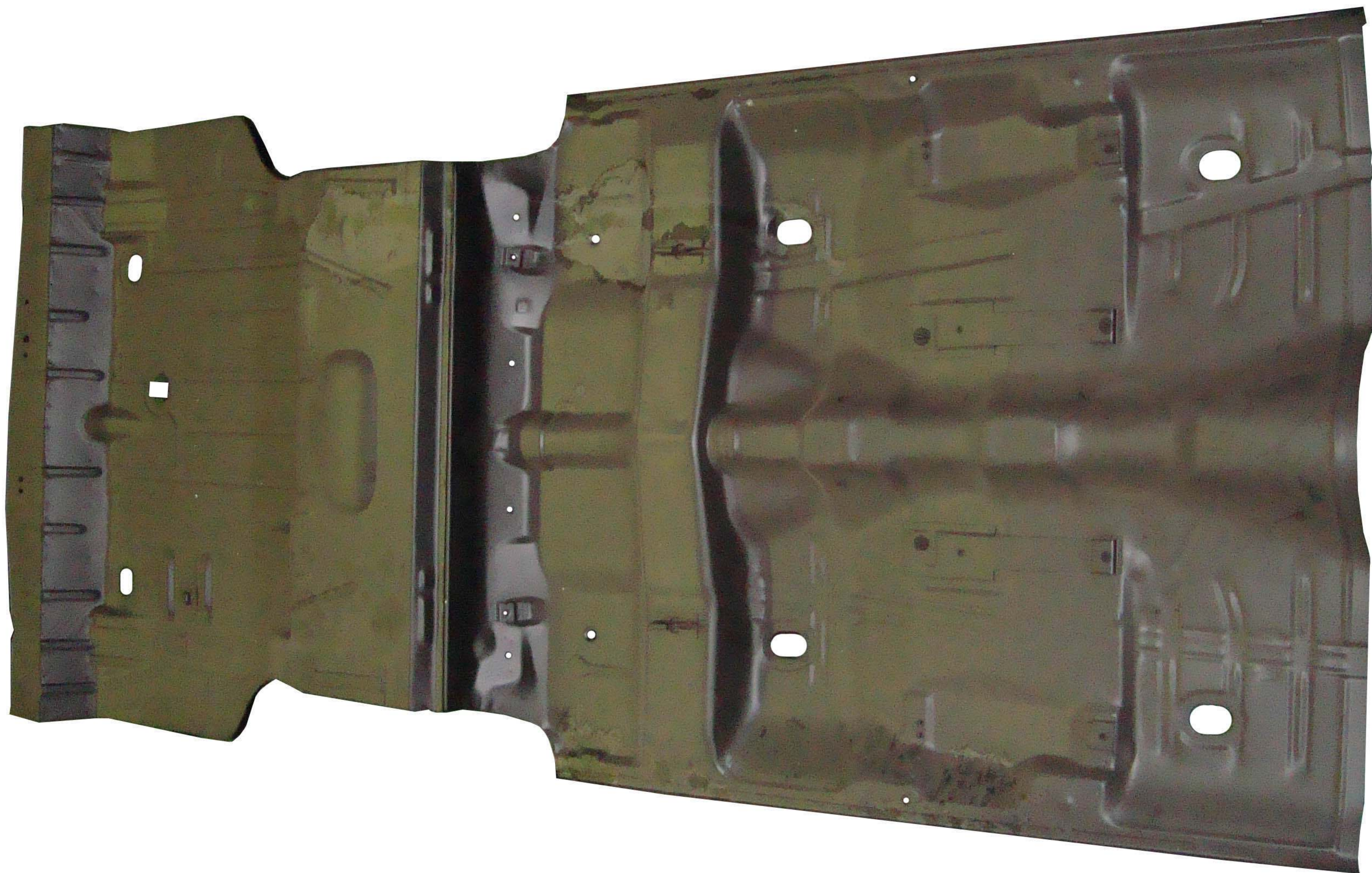



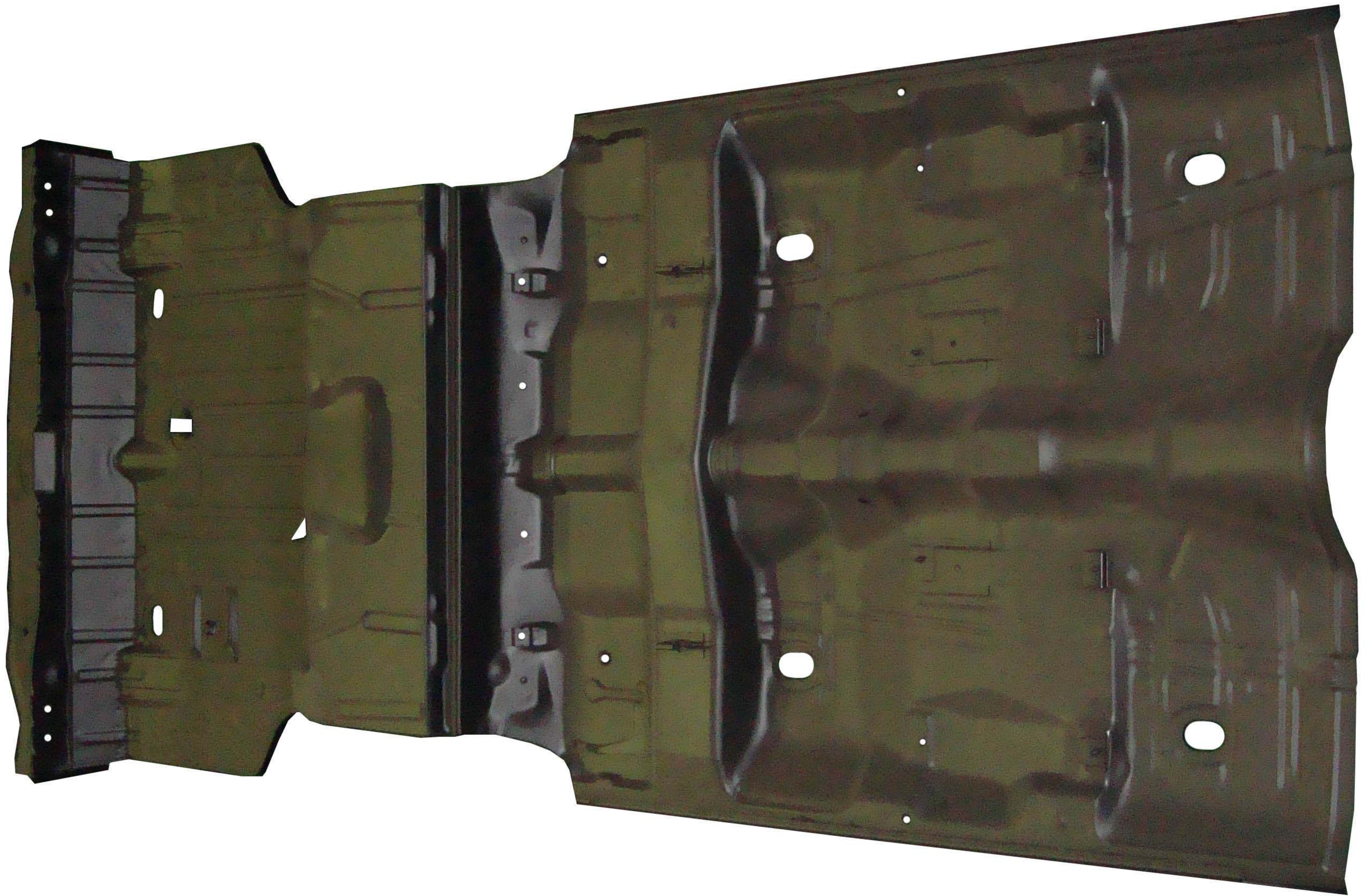

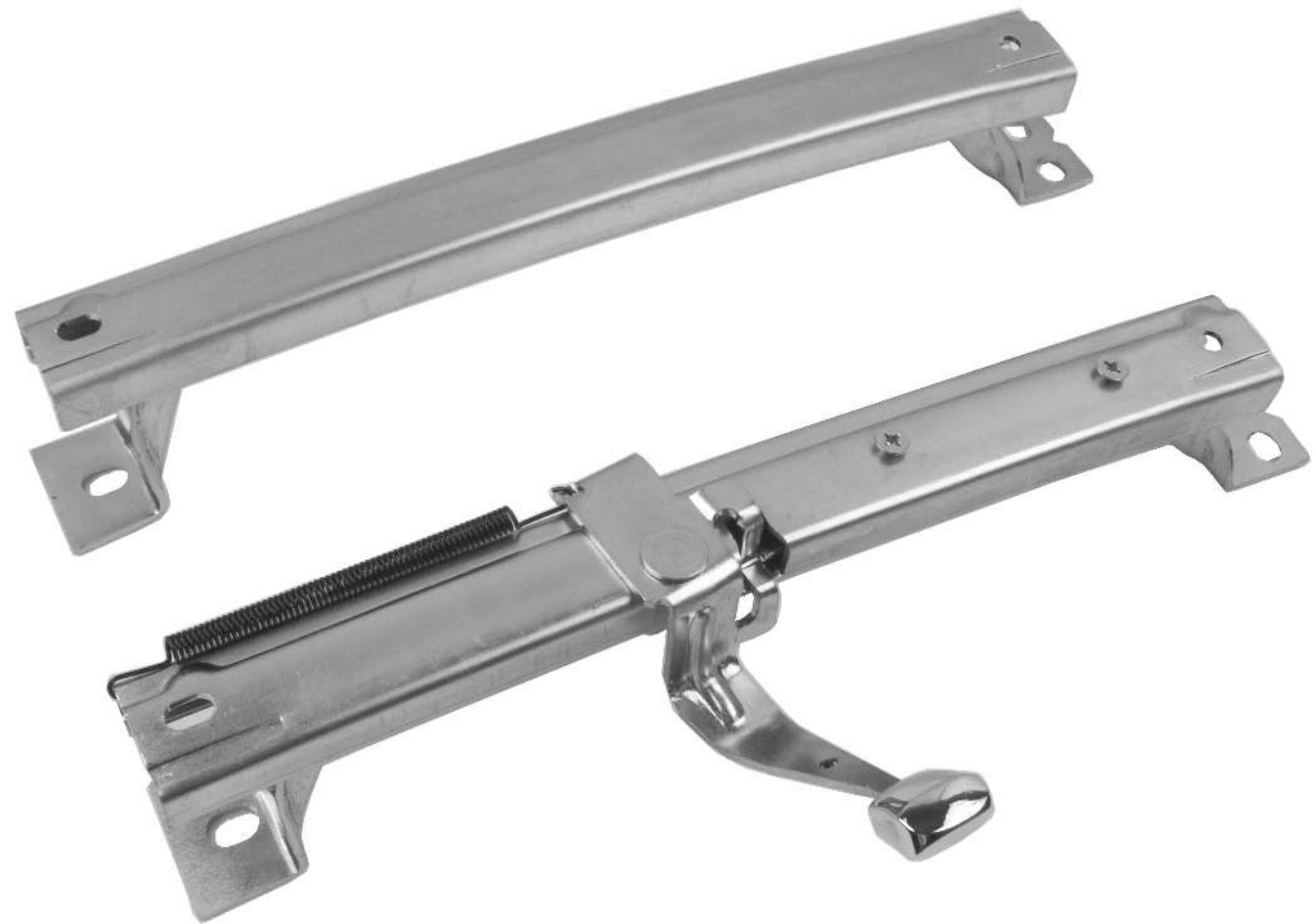

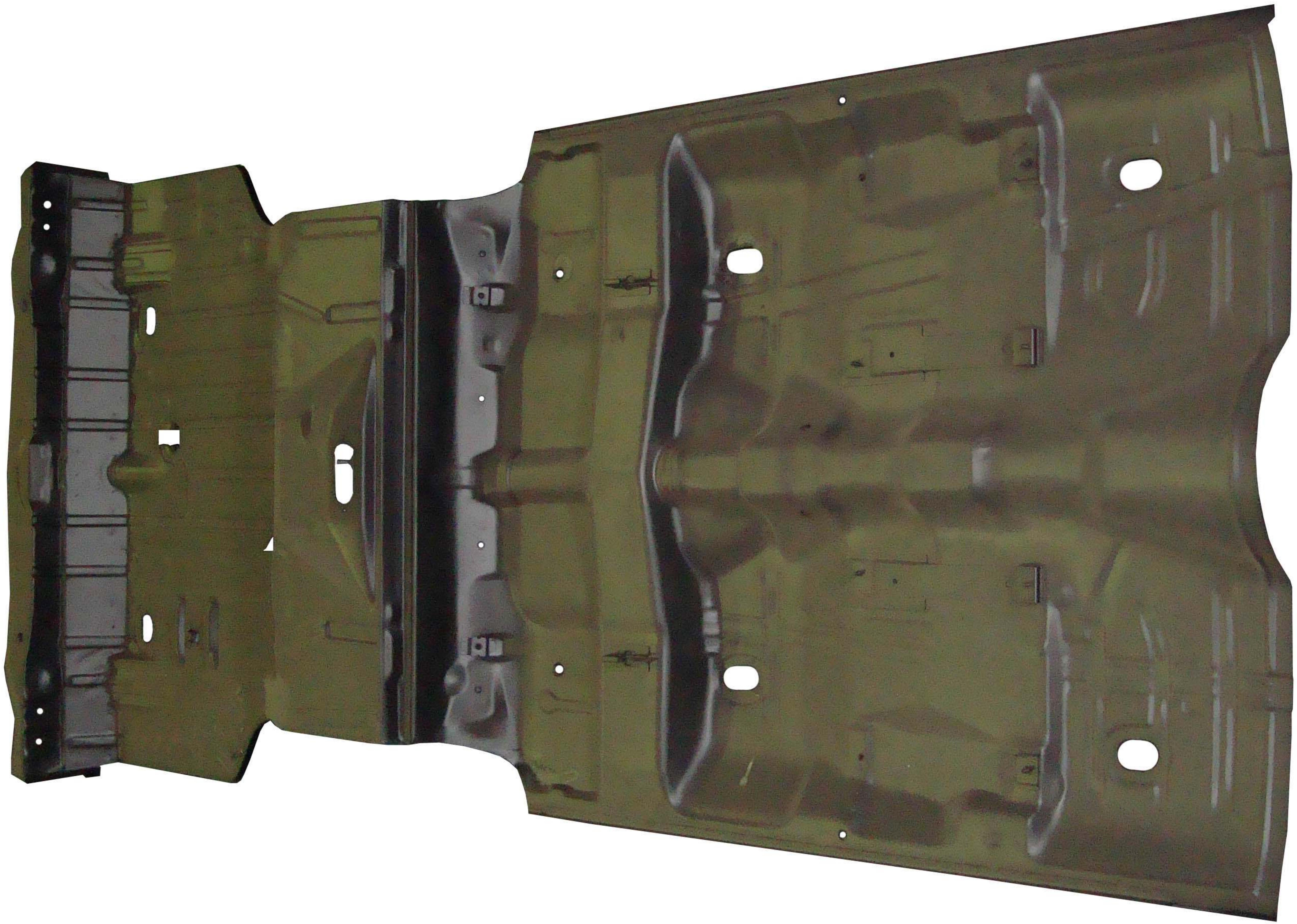

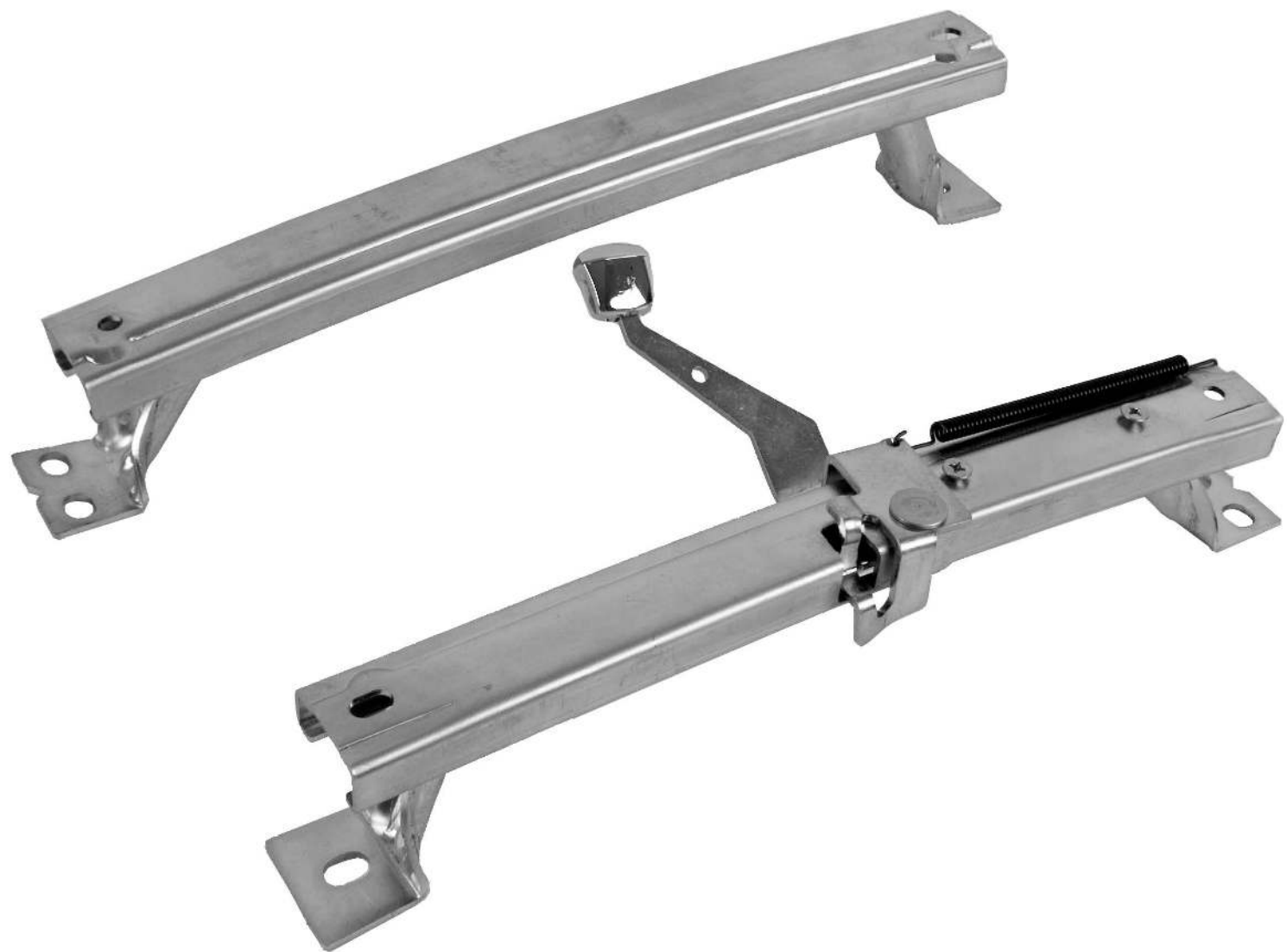









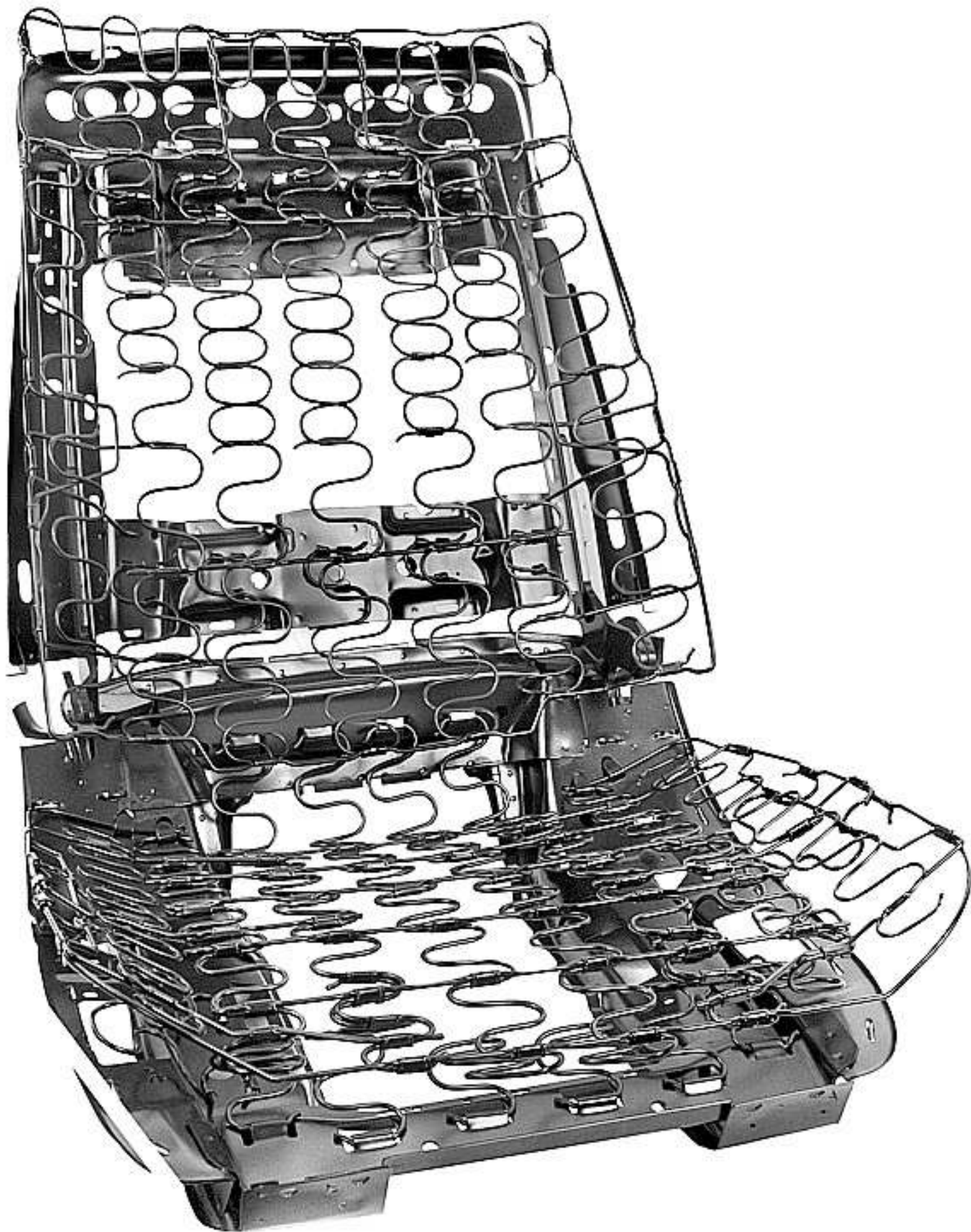

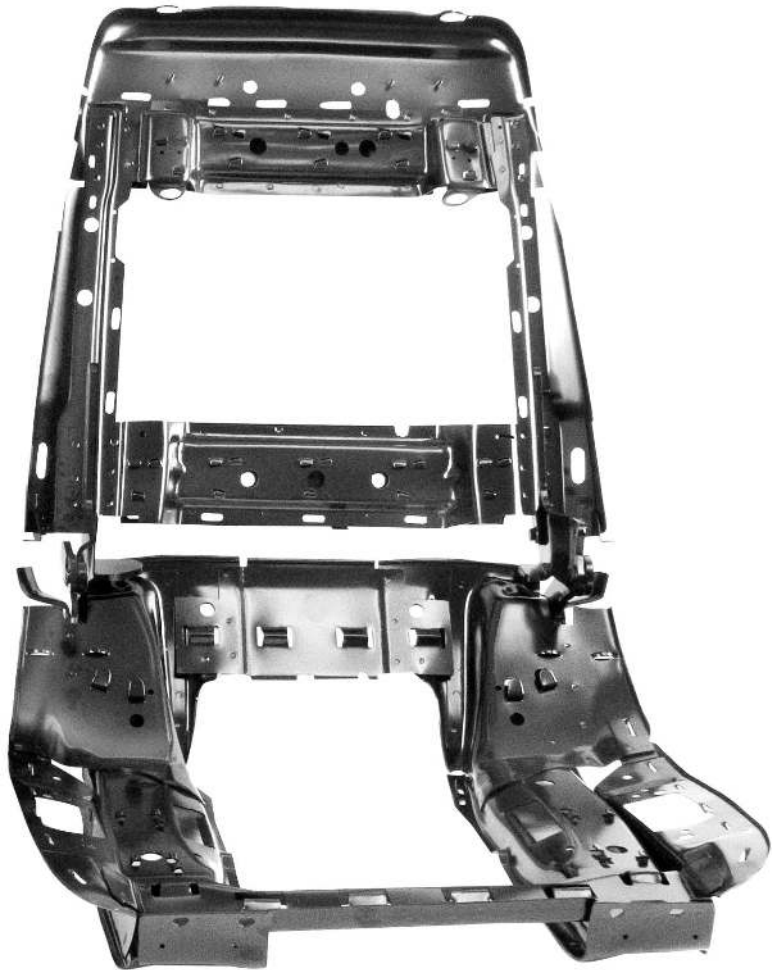

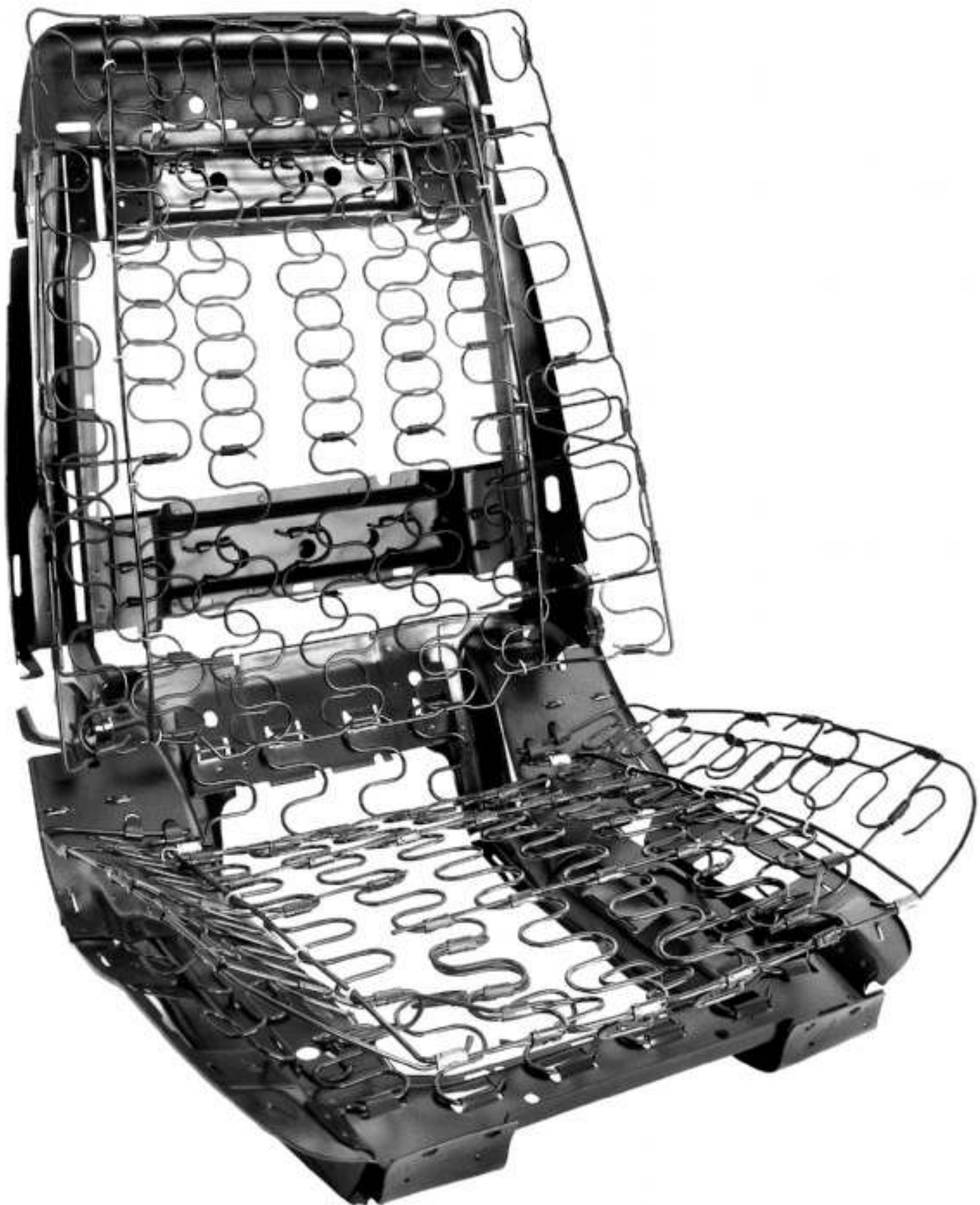

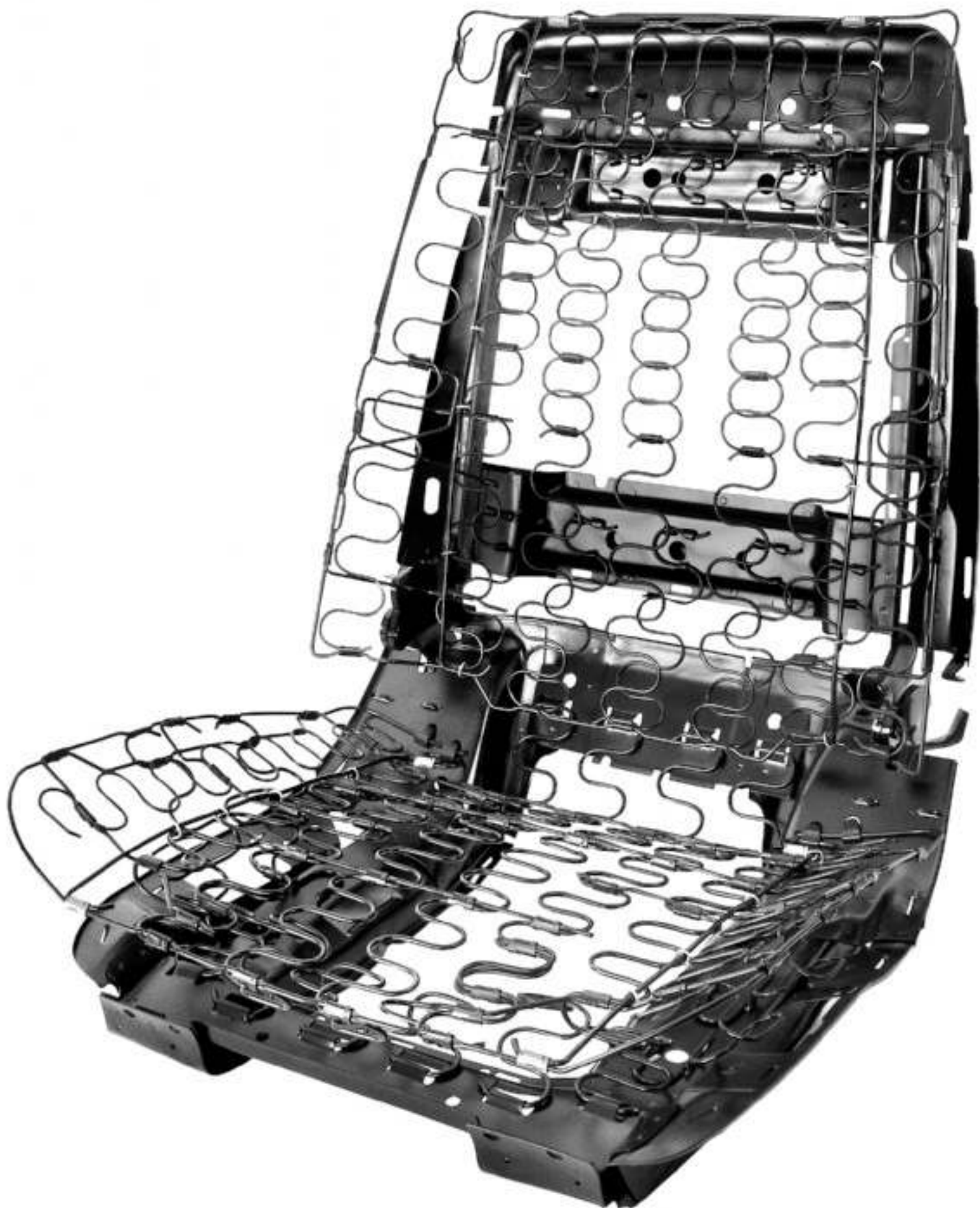













































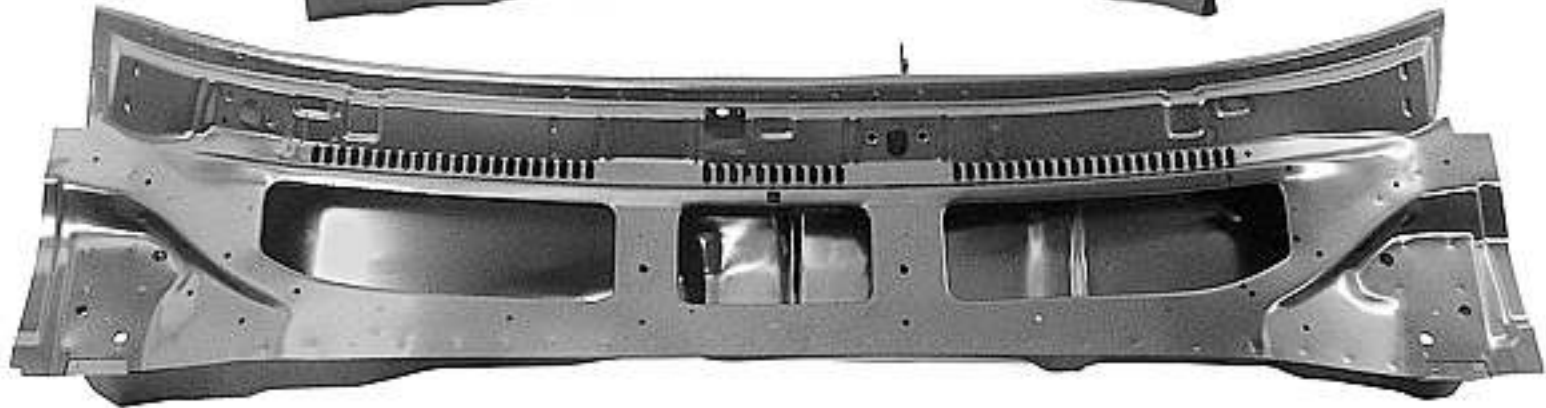











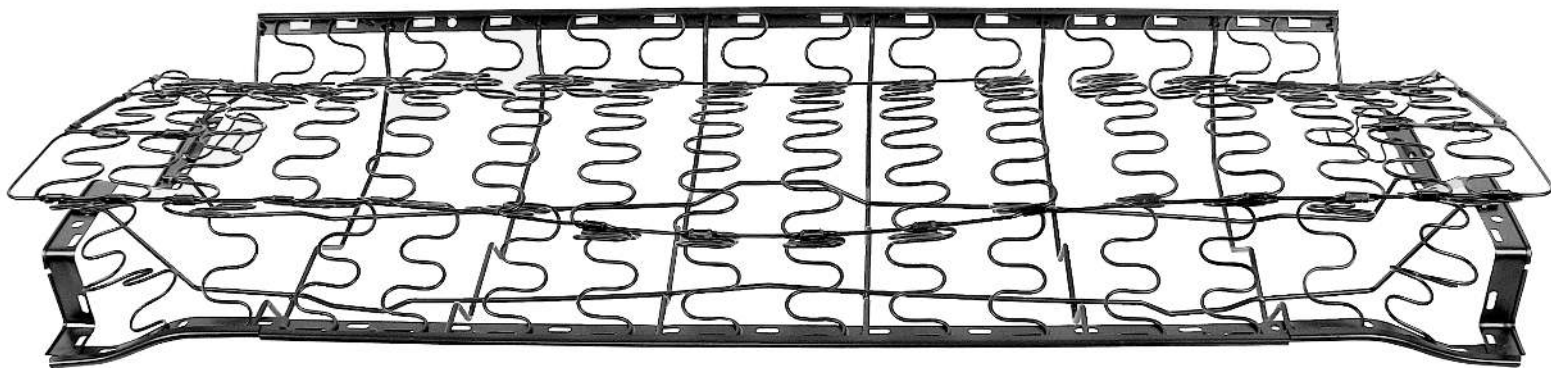
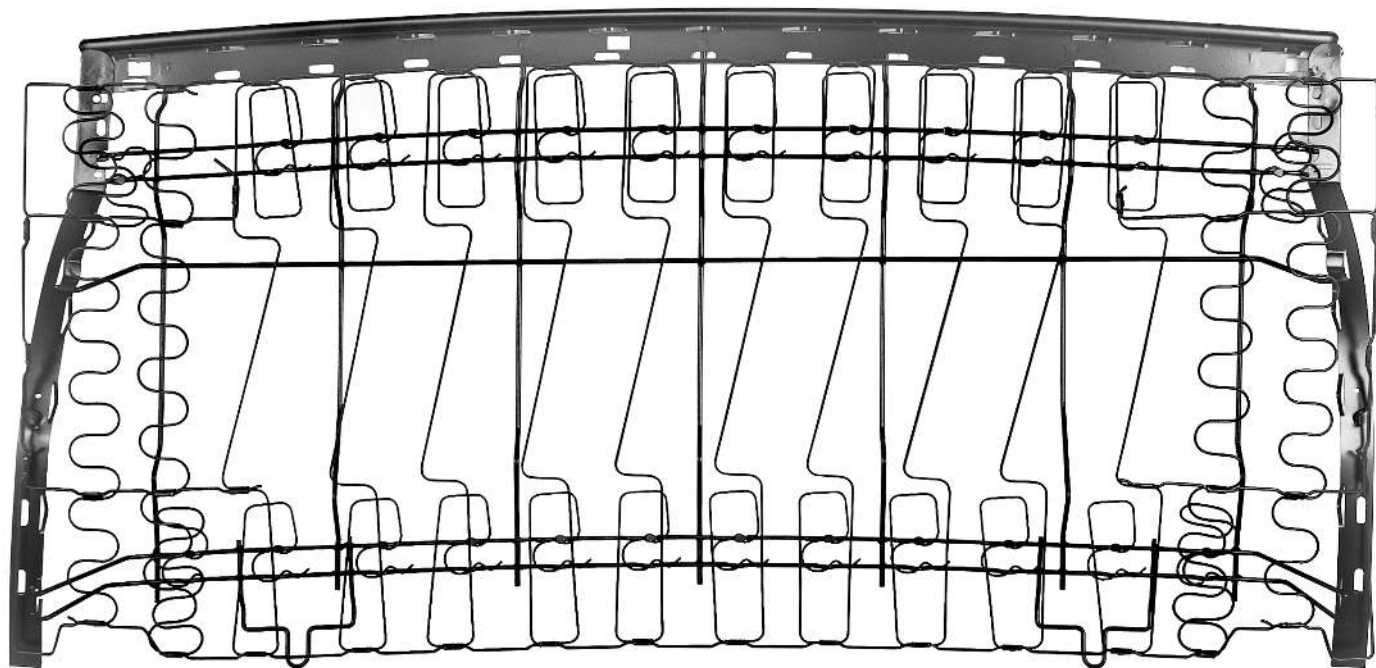

Box Size:

52.5" x 26.75" x 12.75"

Weight:

31.5 lbs.









BRAKE RELEASE







BRAKE RELEASE



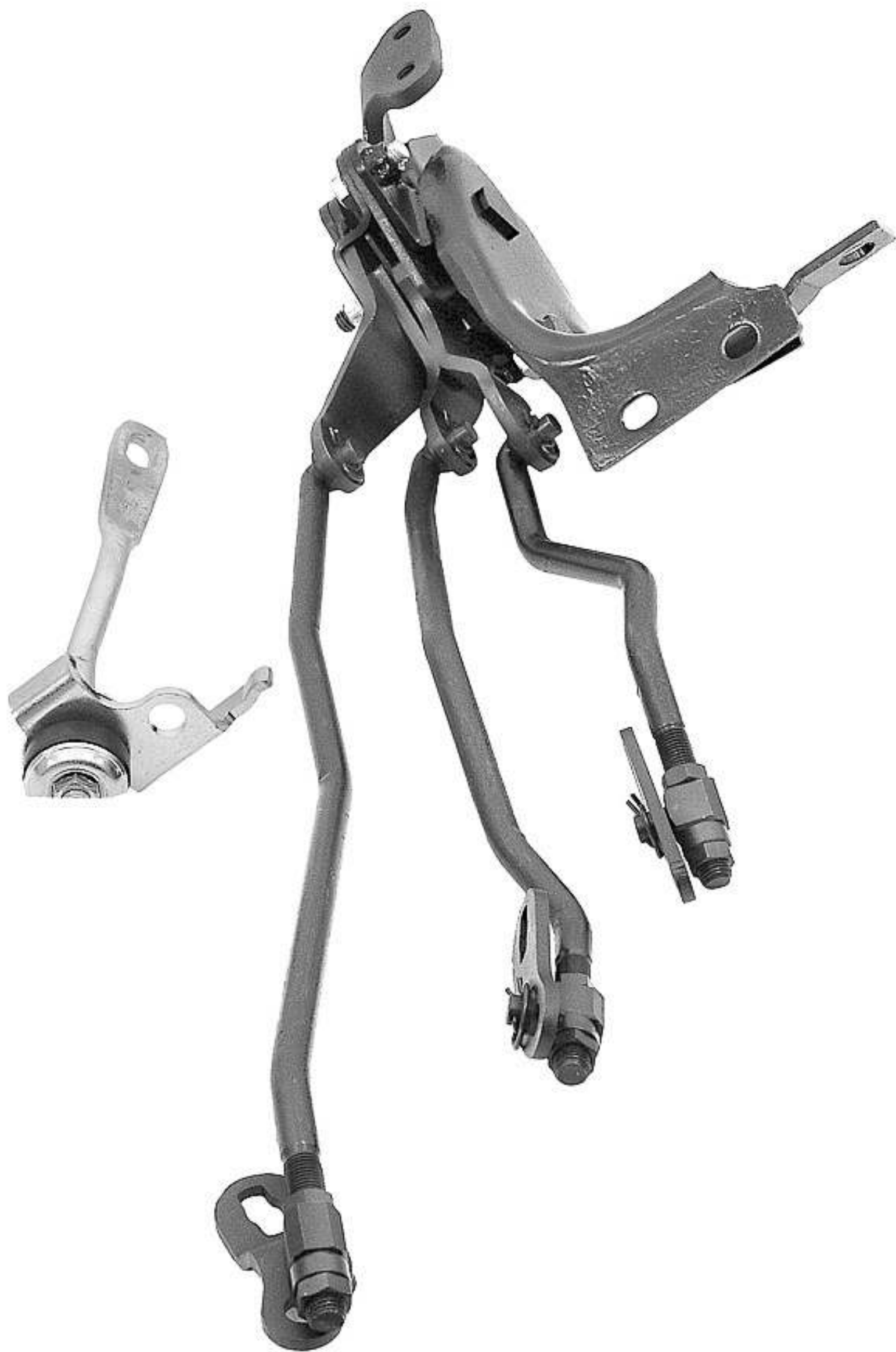



MUNZIE



MUNGE



















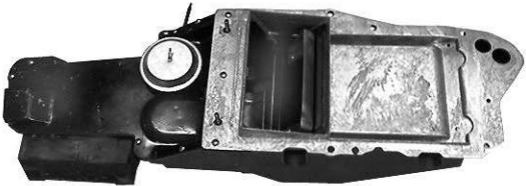

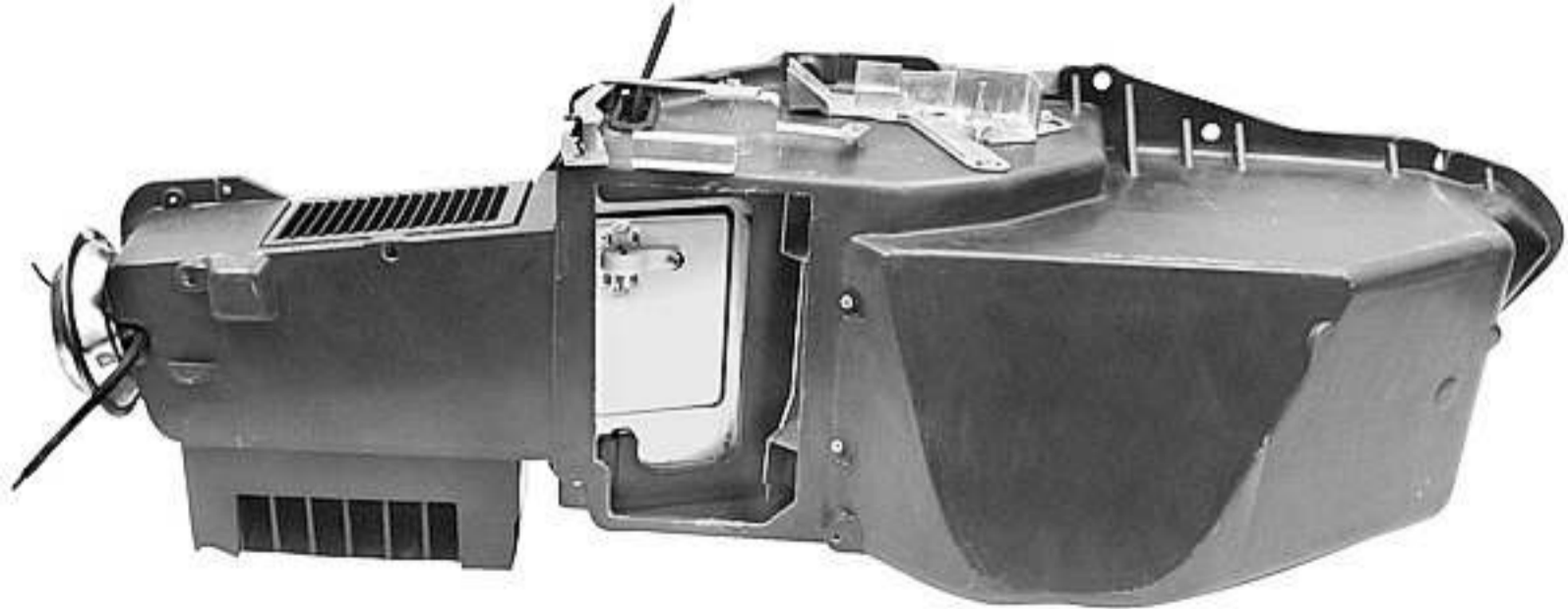



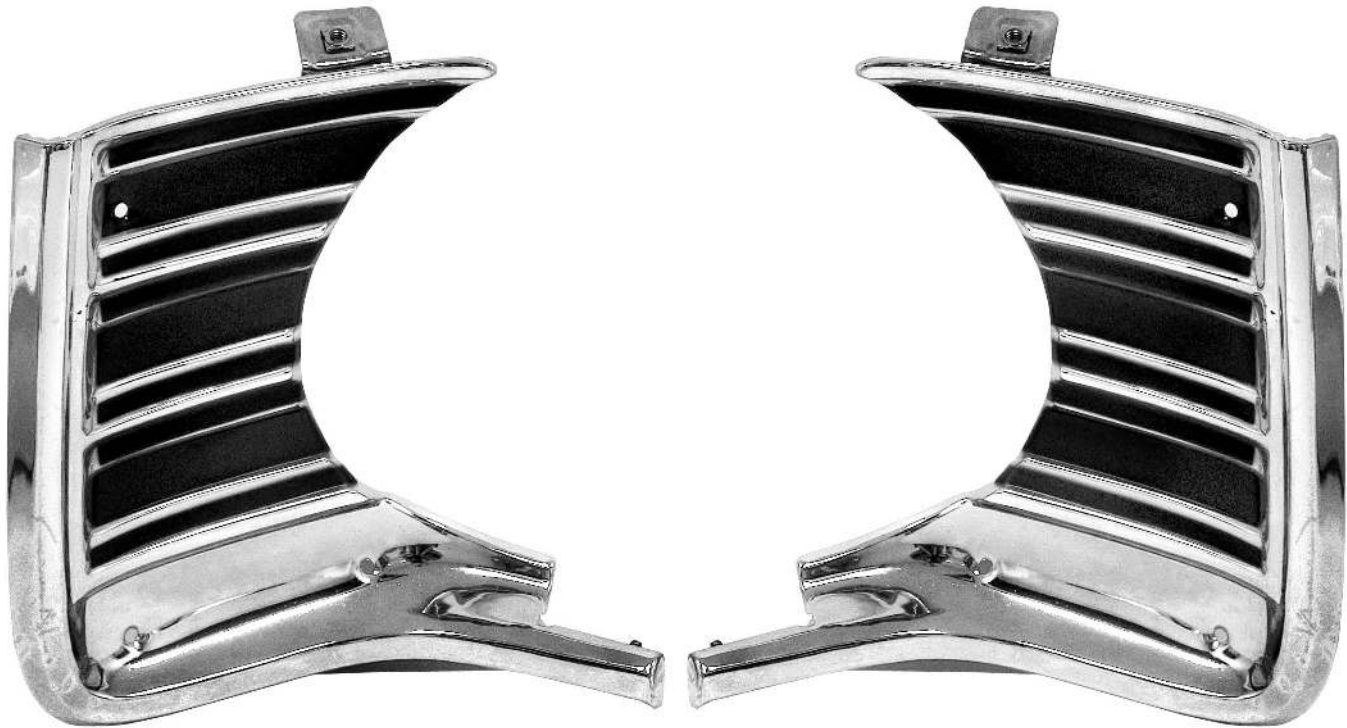

































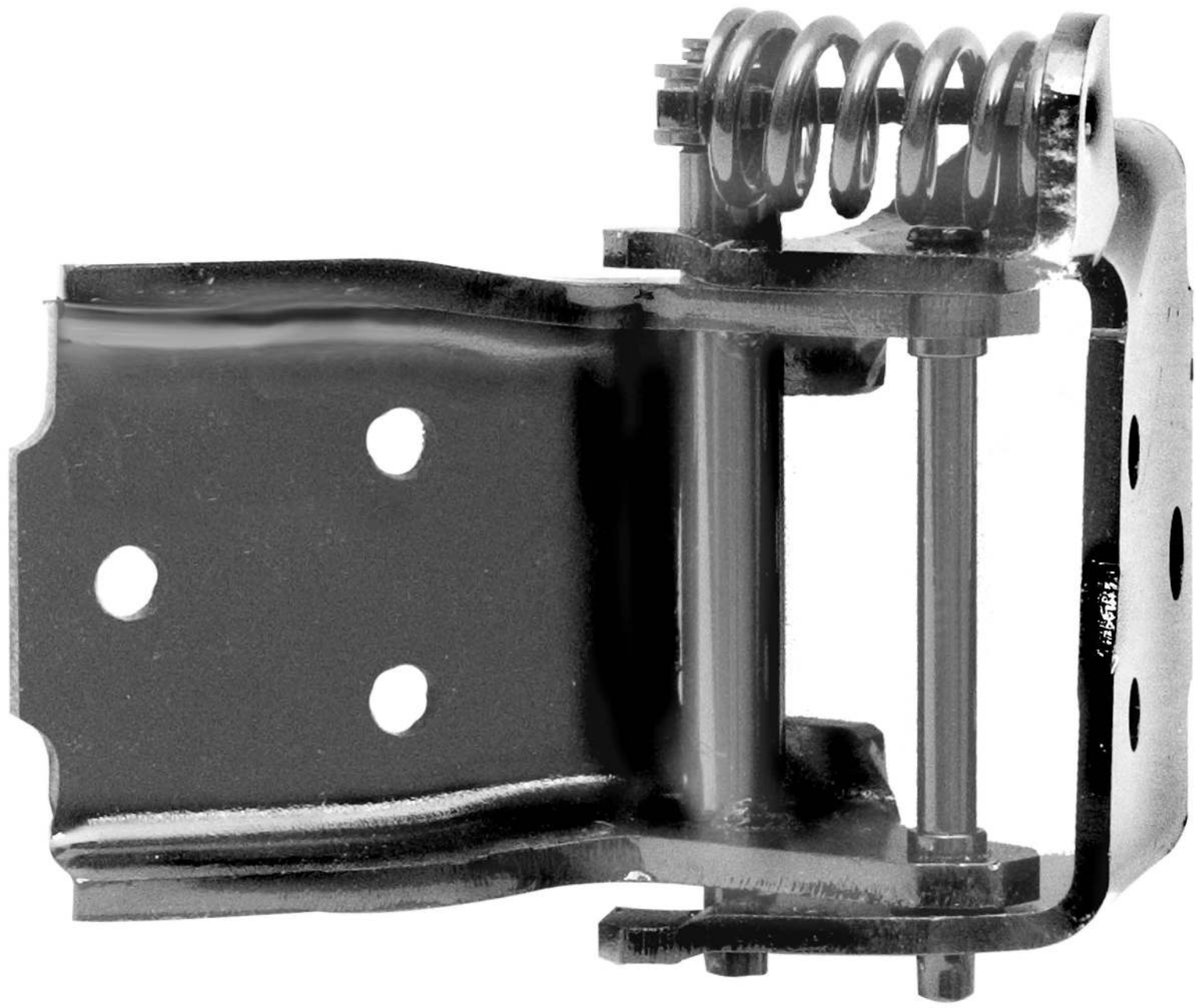

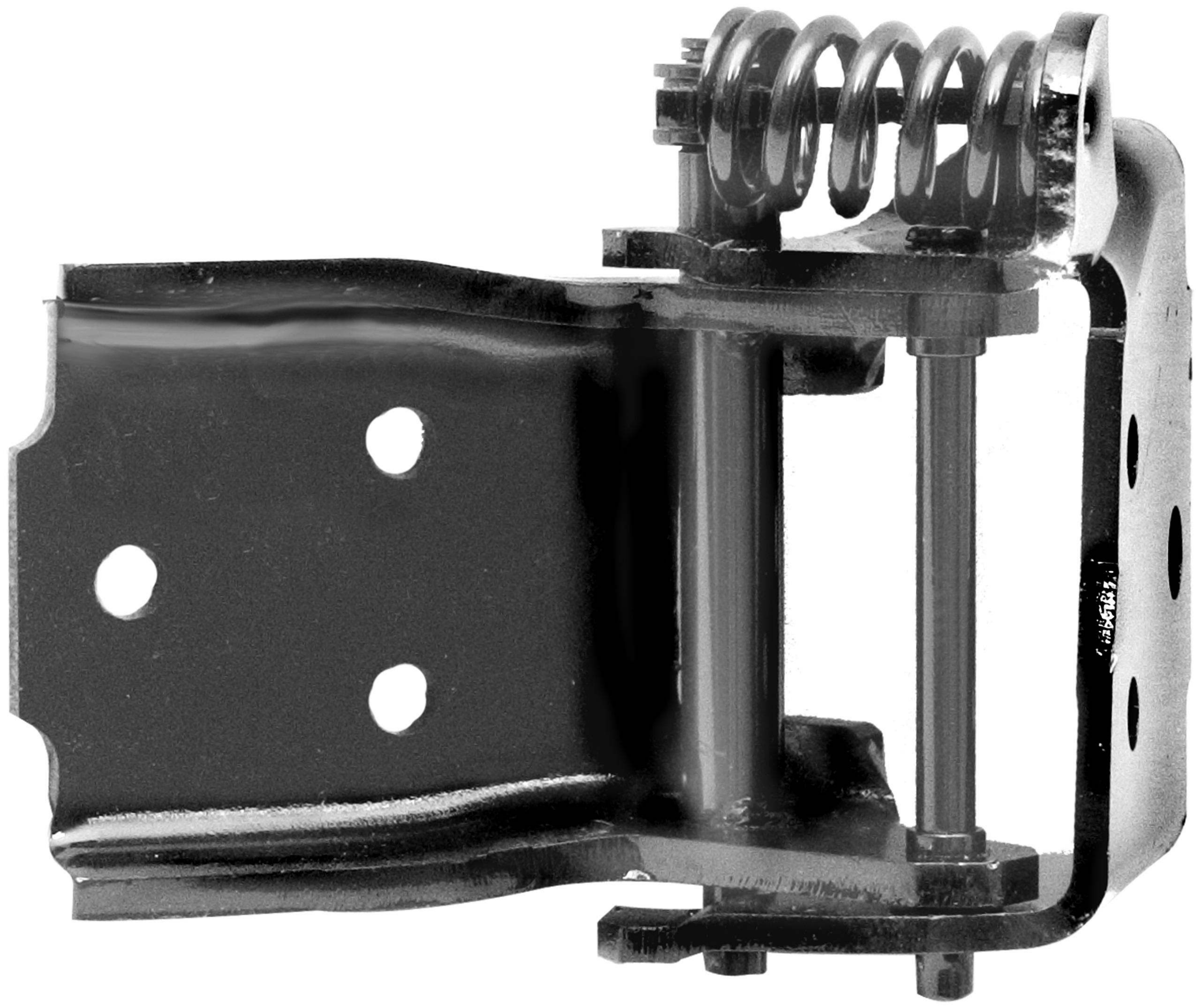

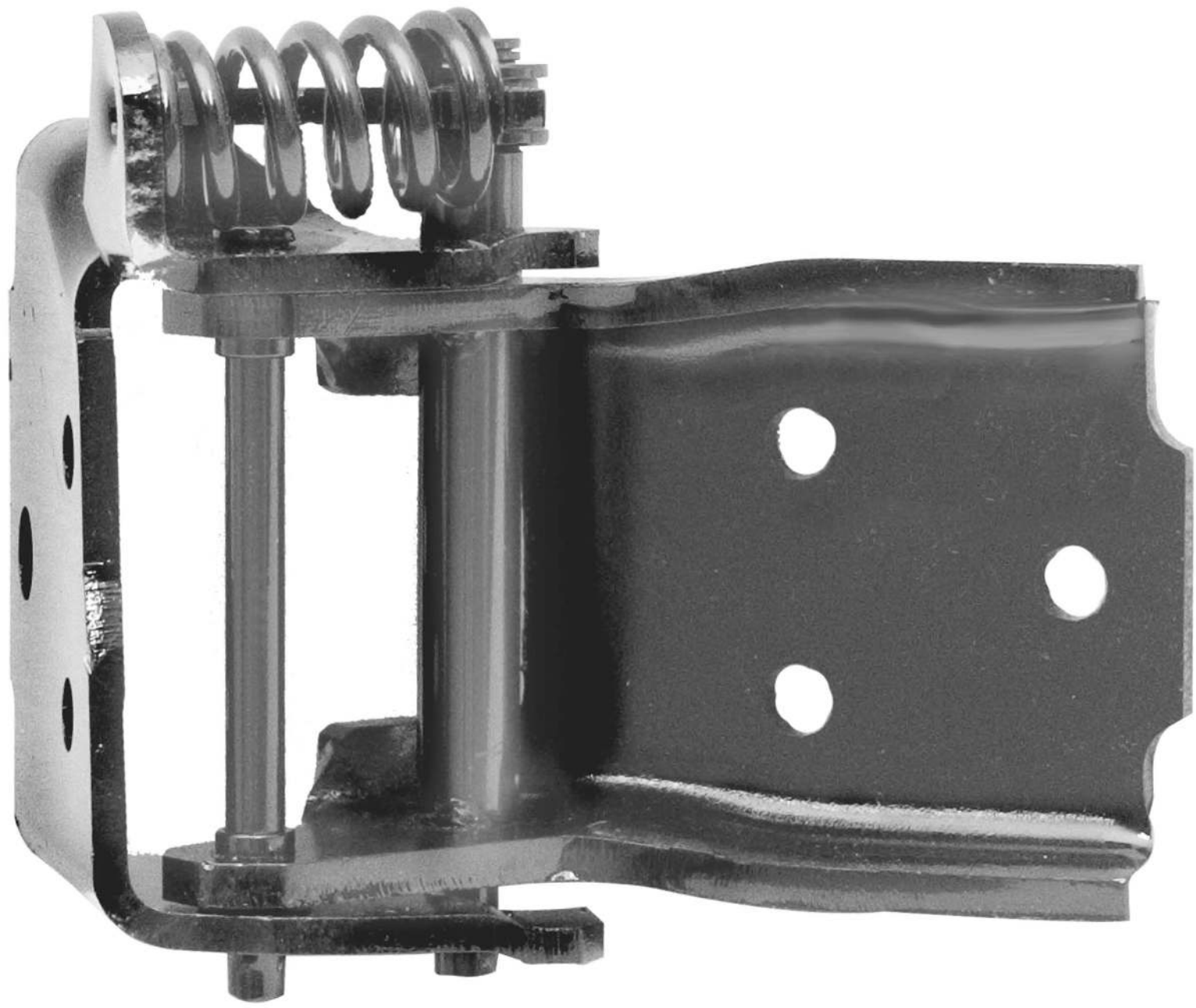

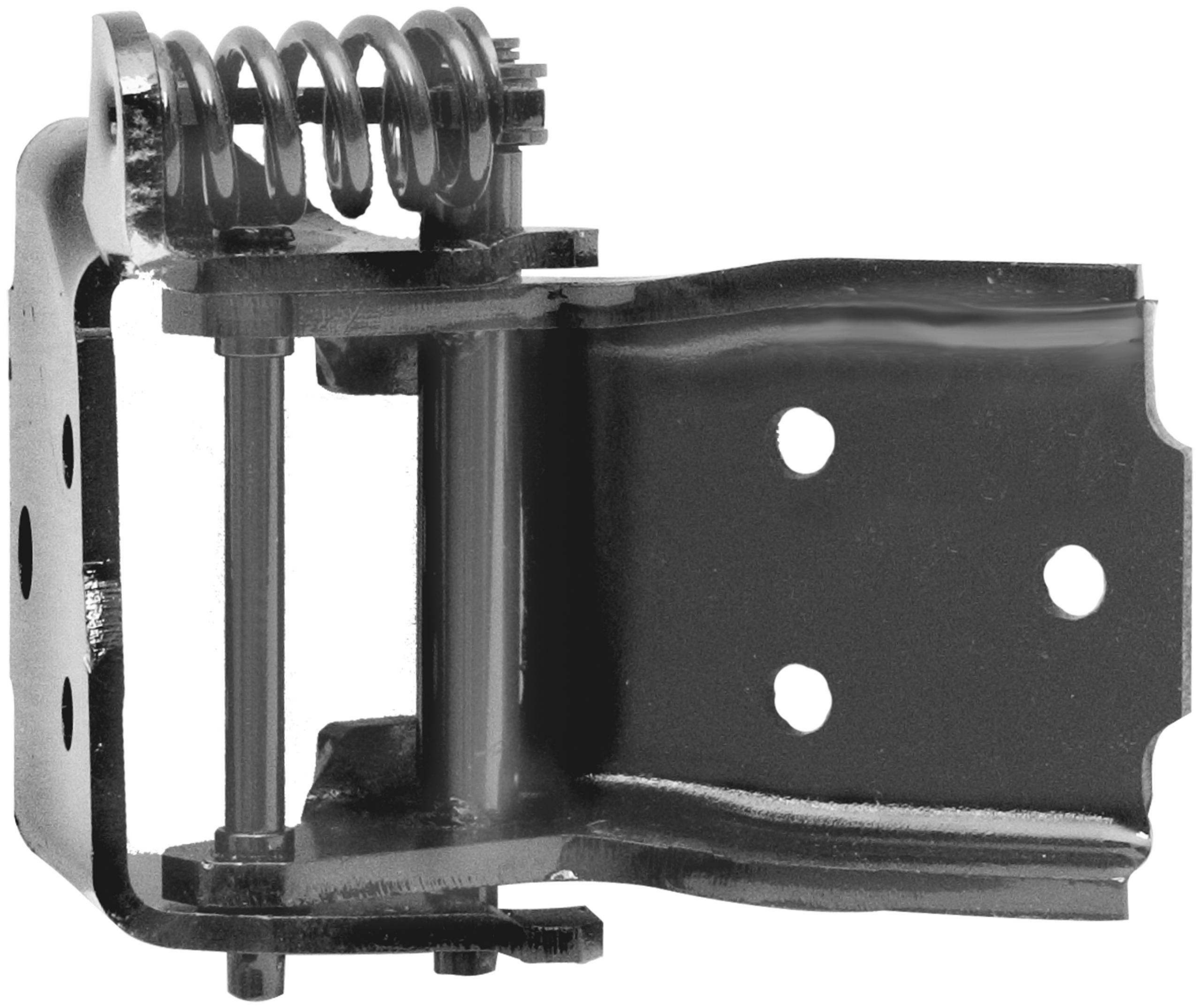

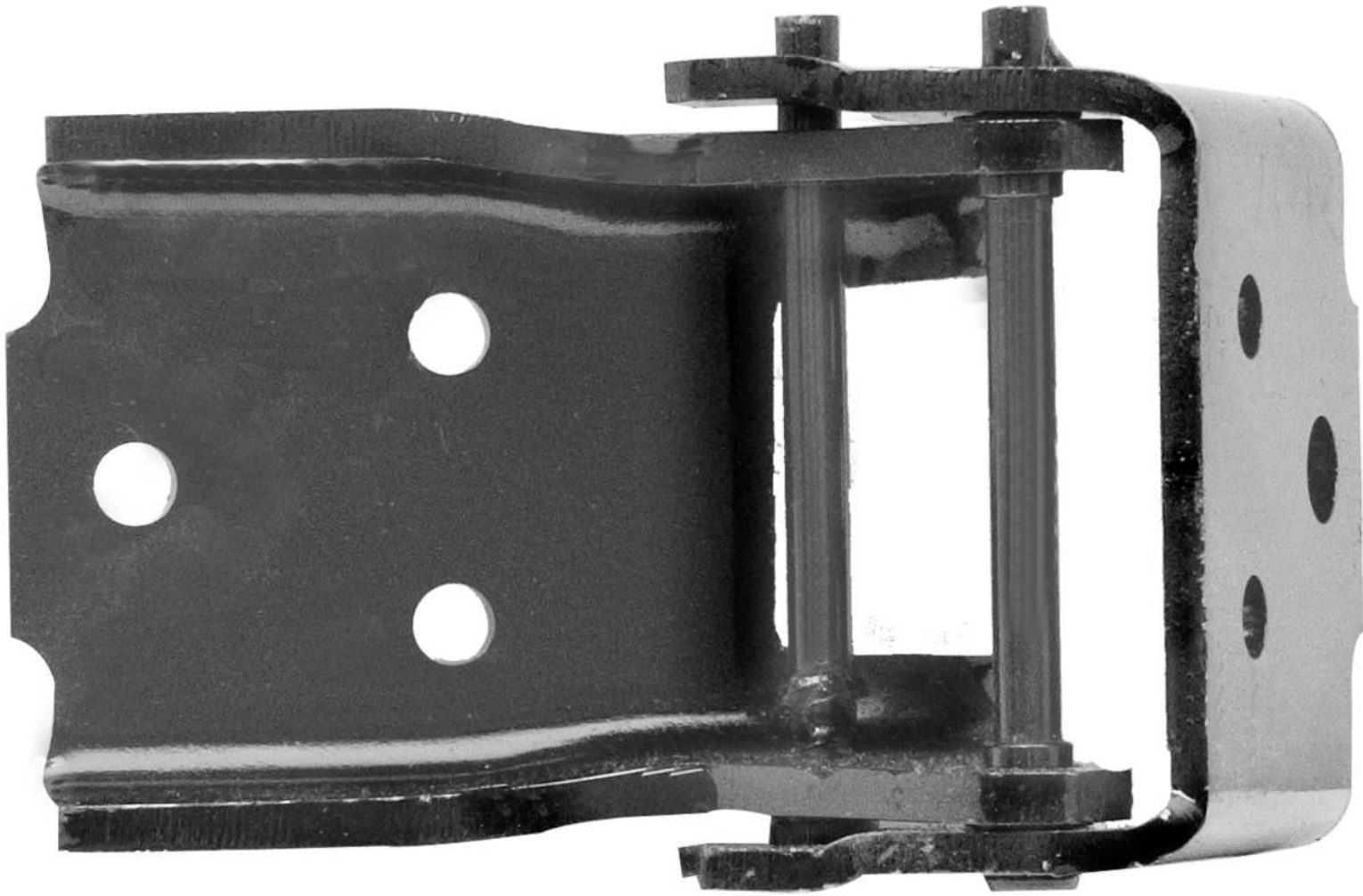

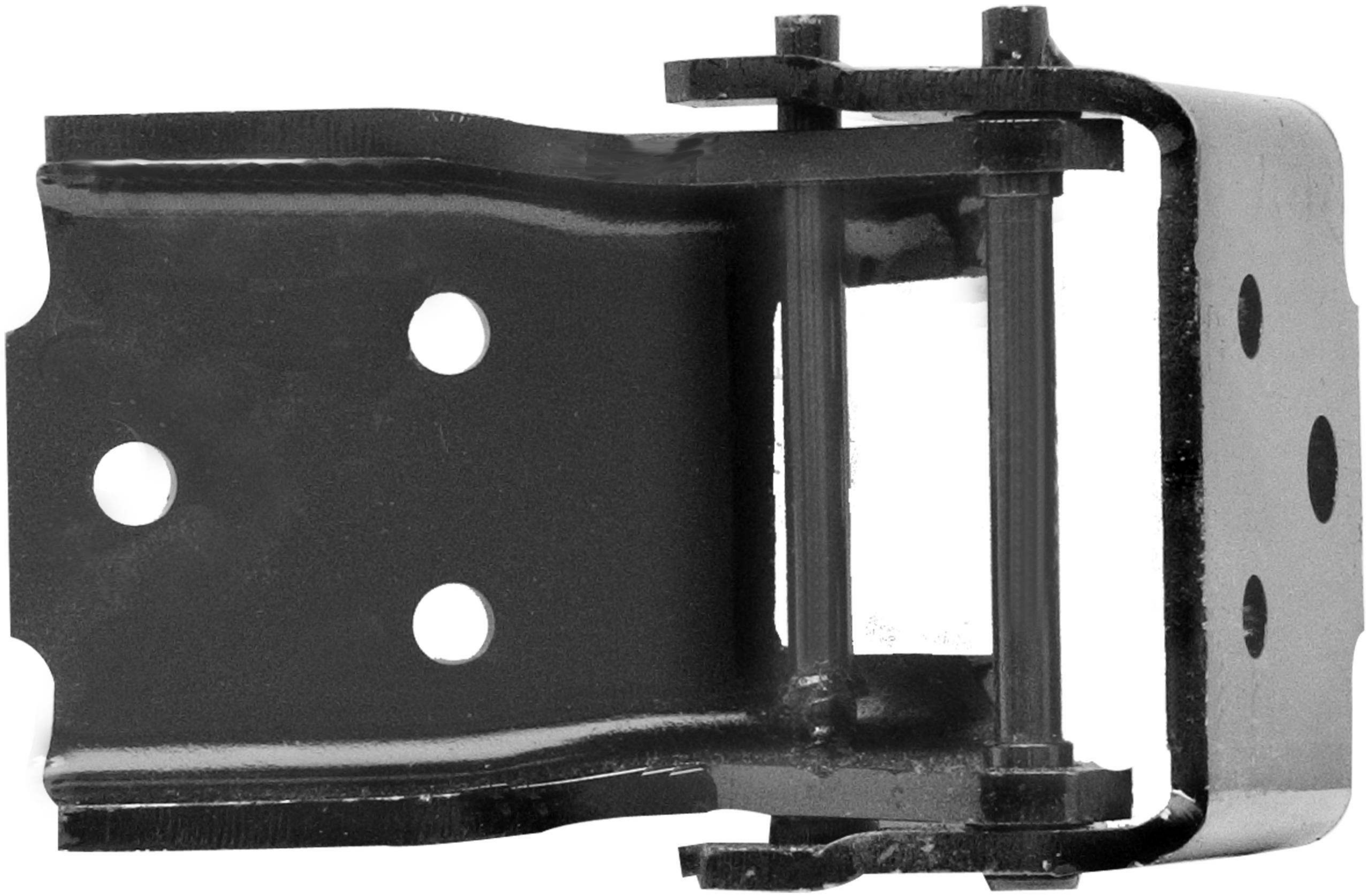

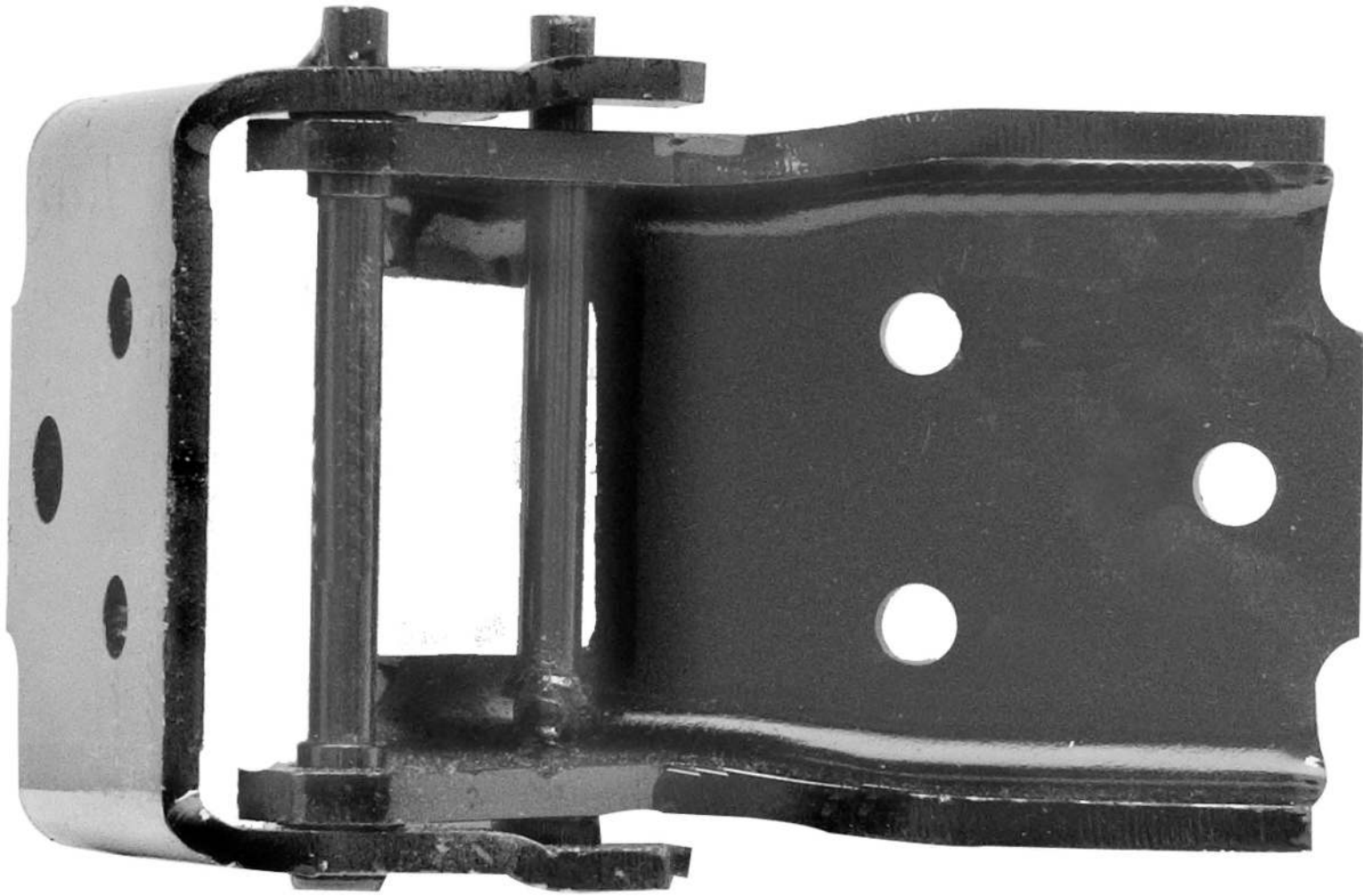

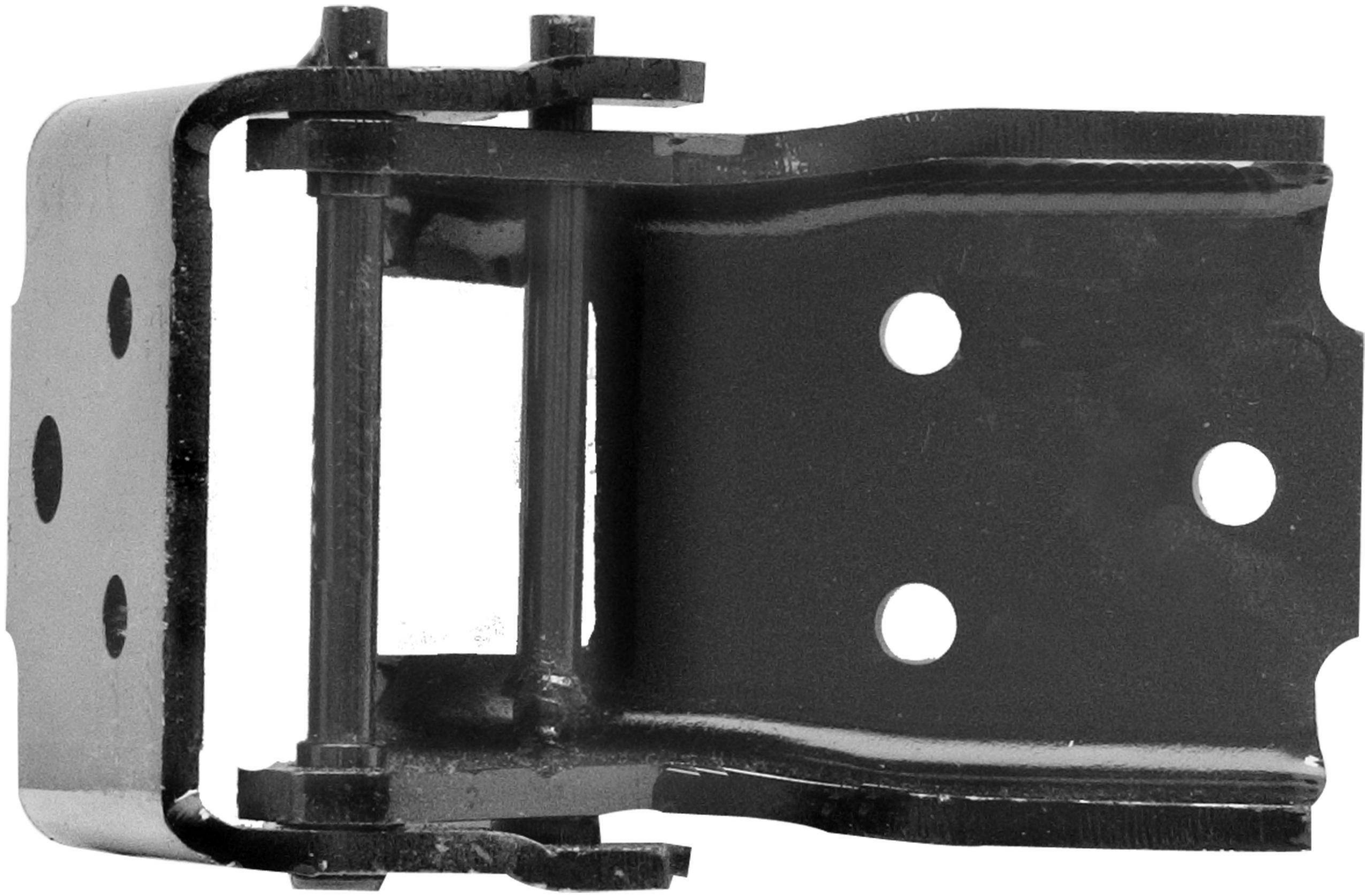

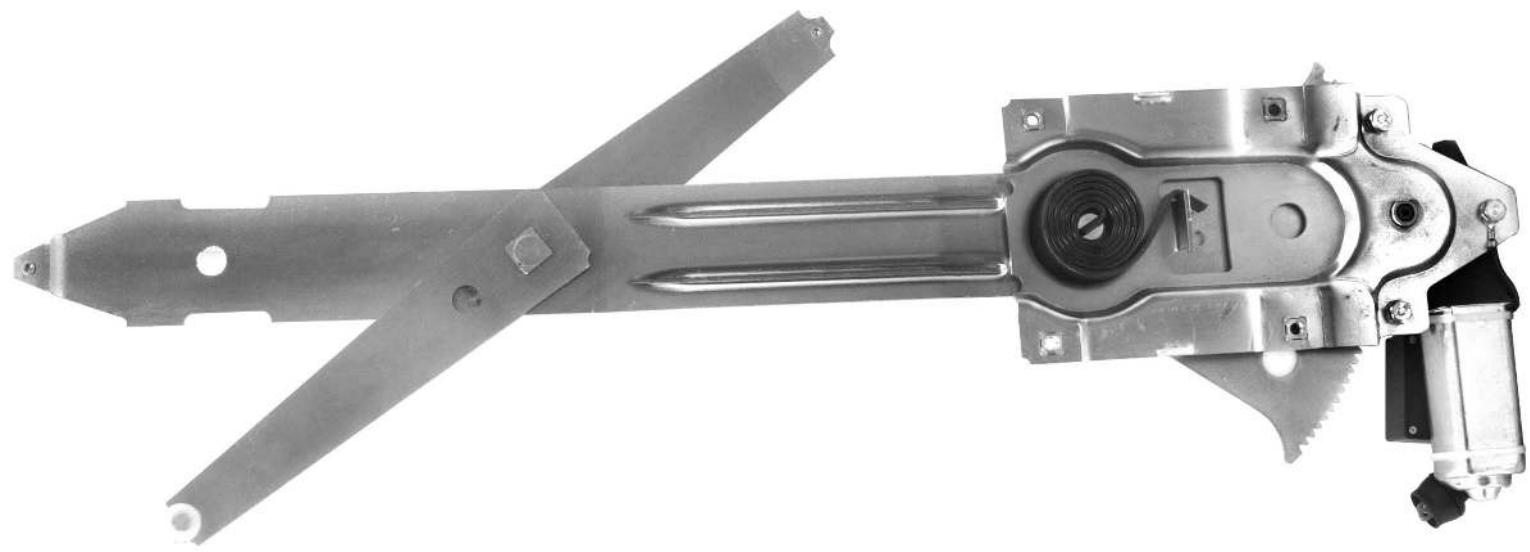

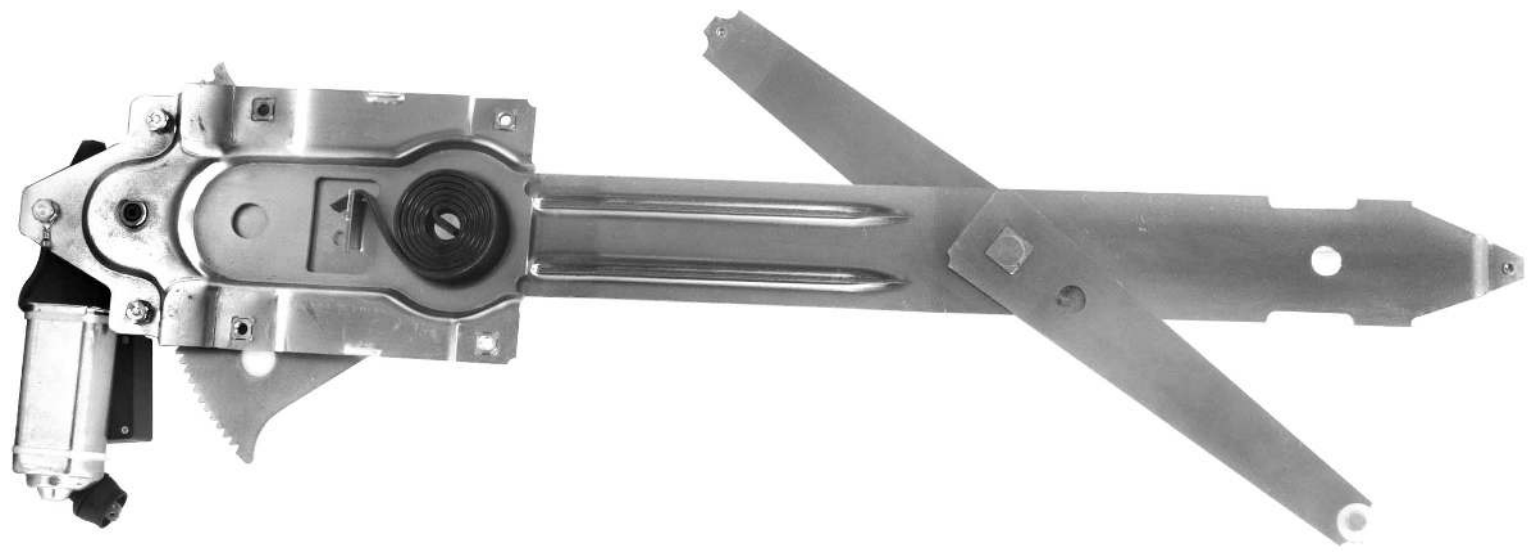





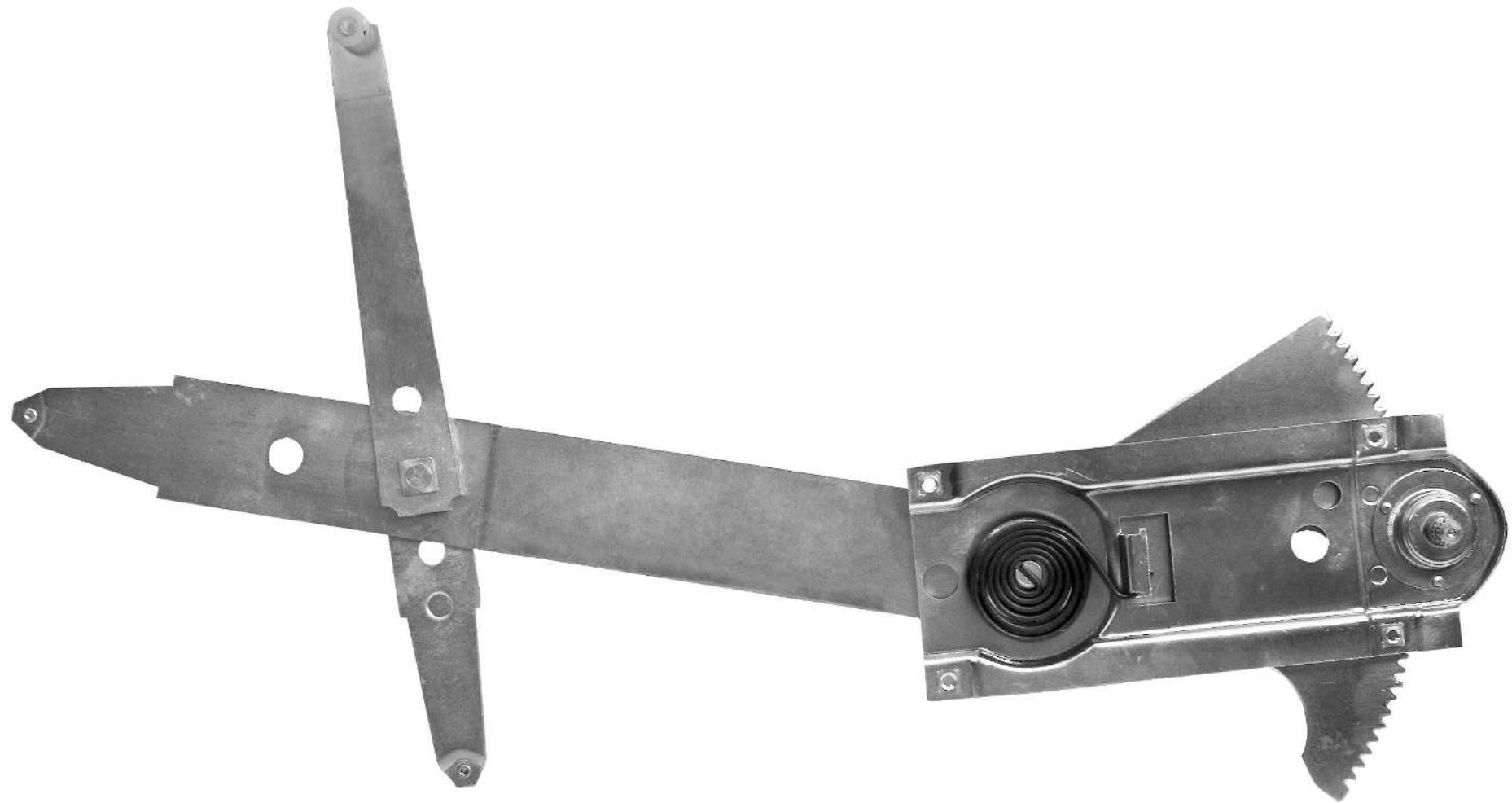

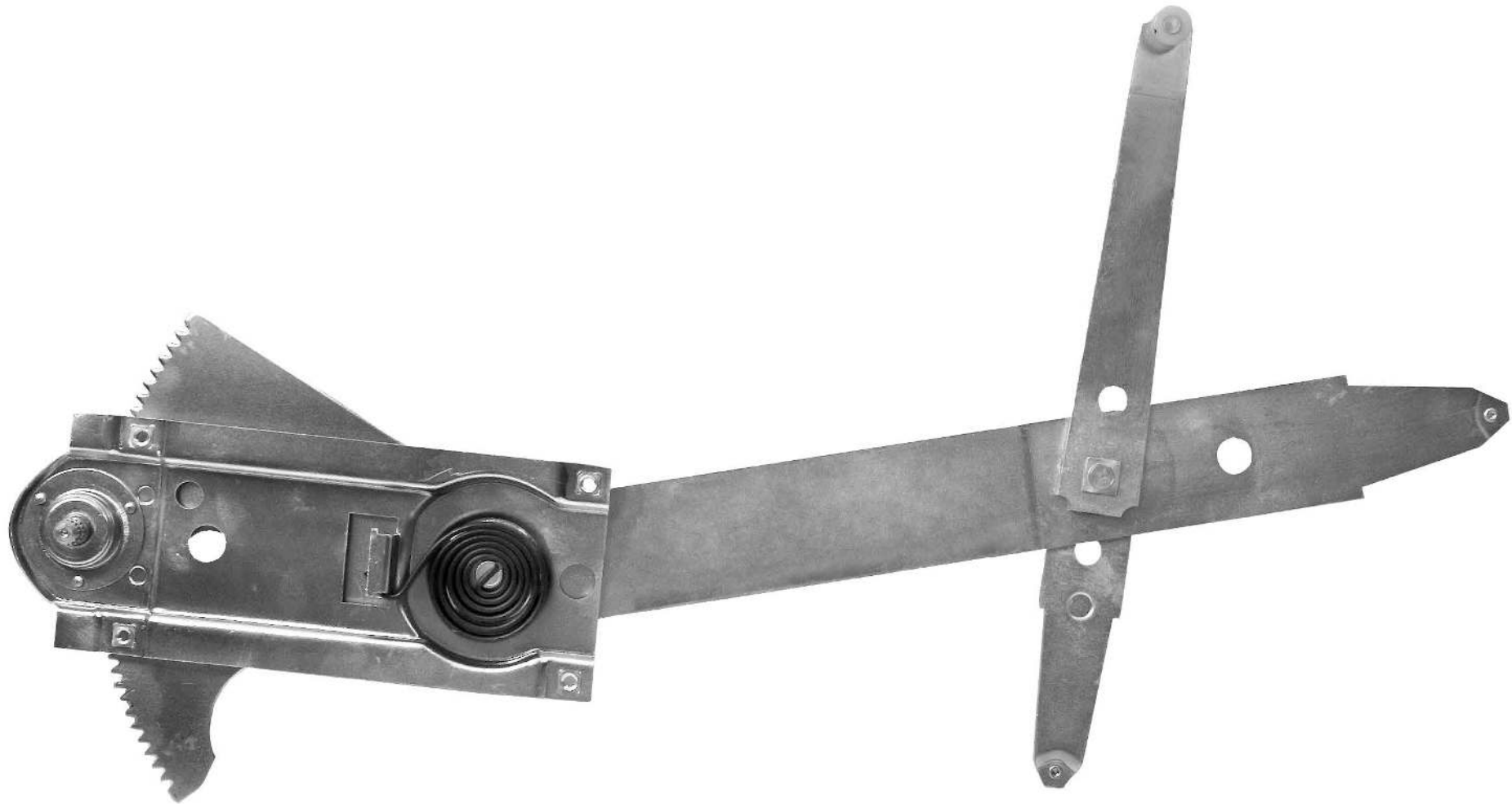





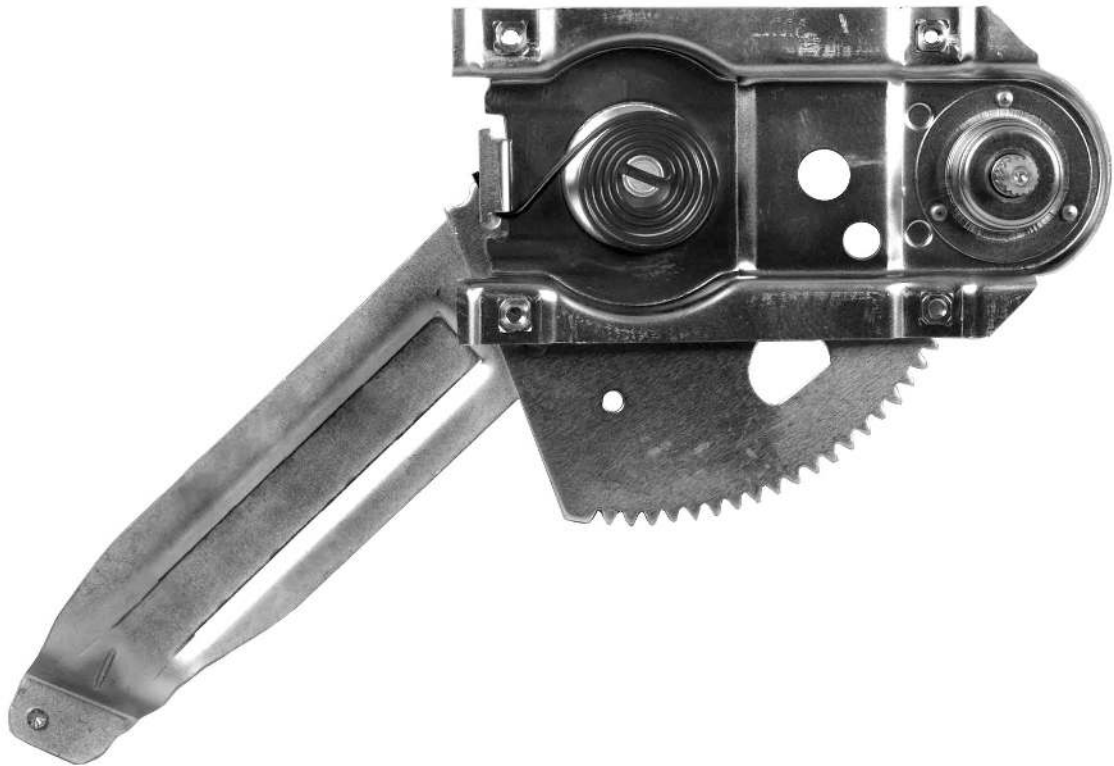

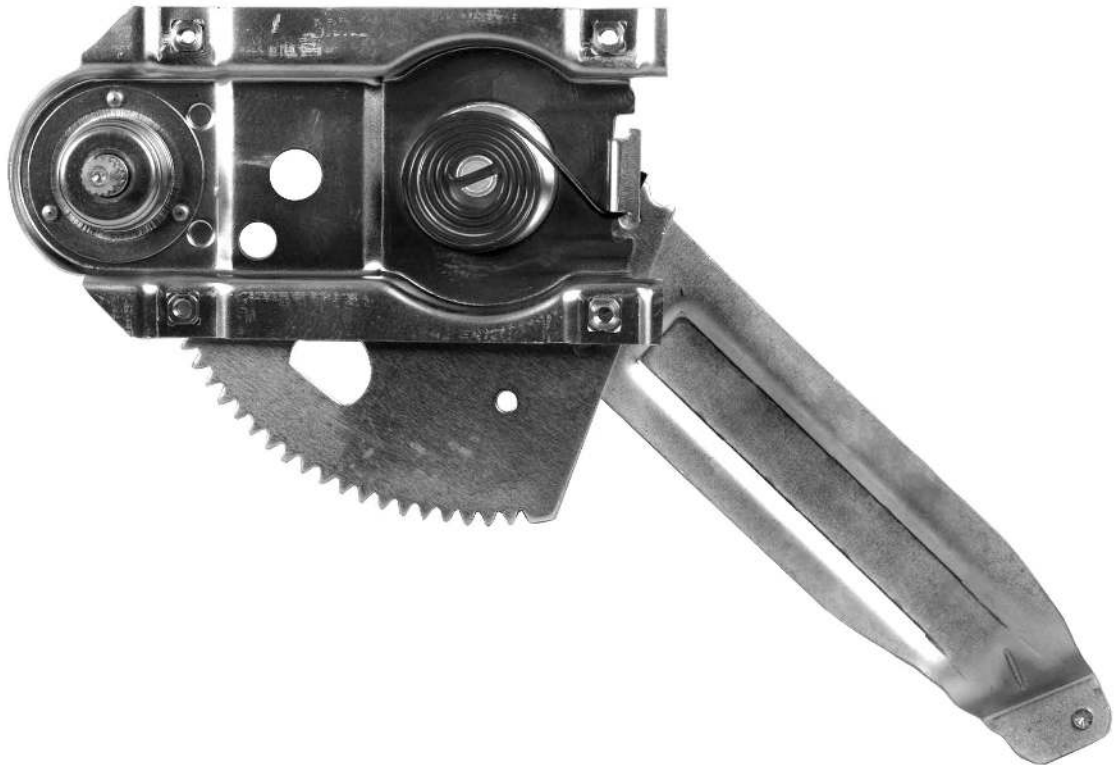









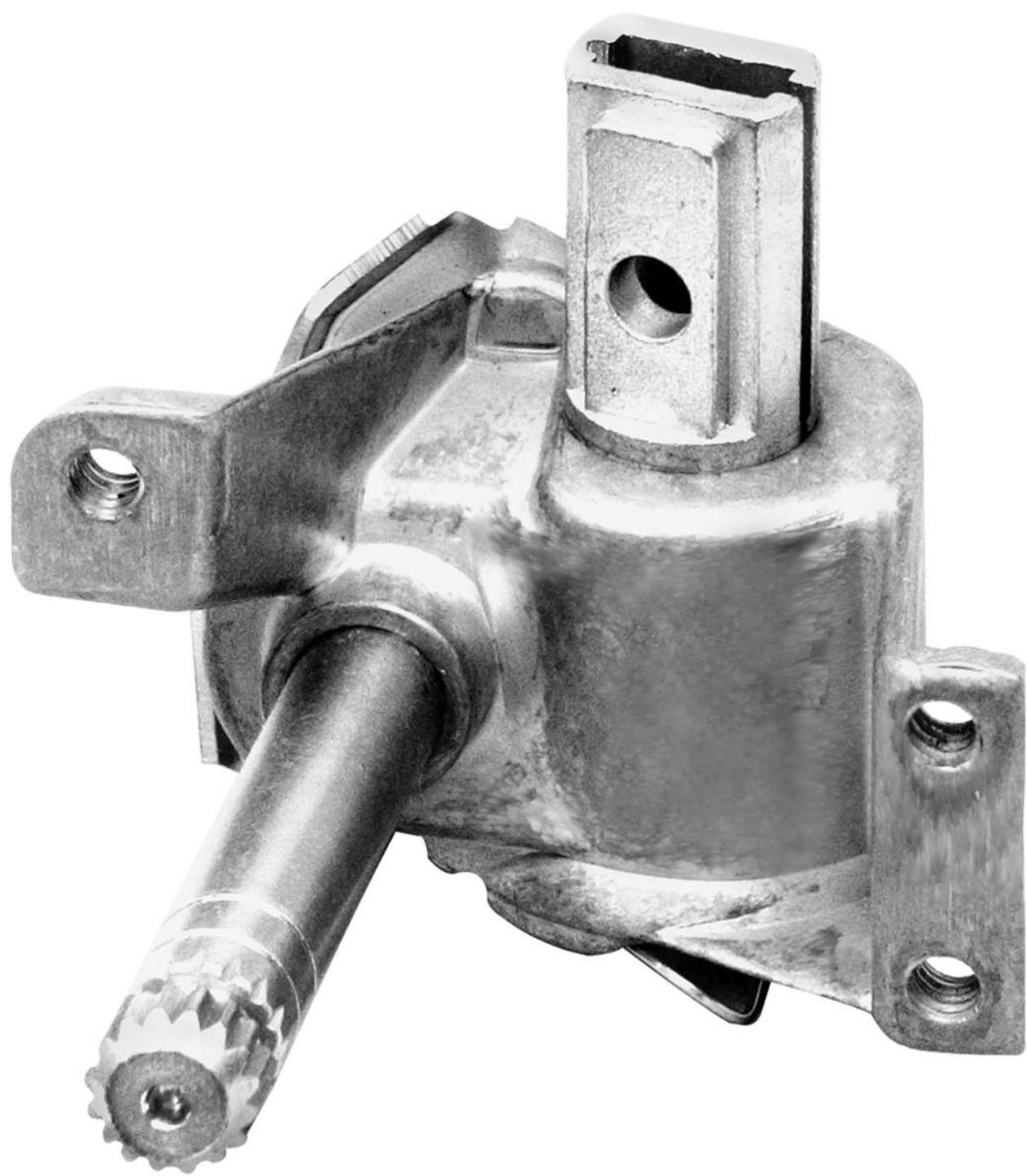









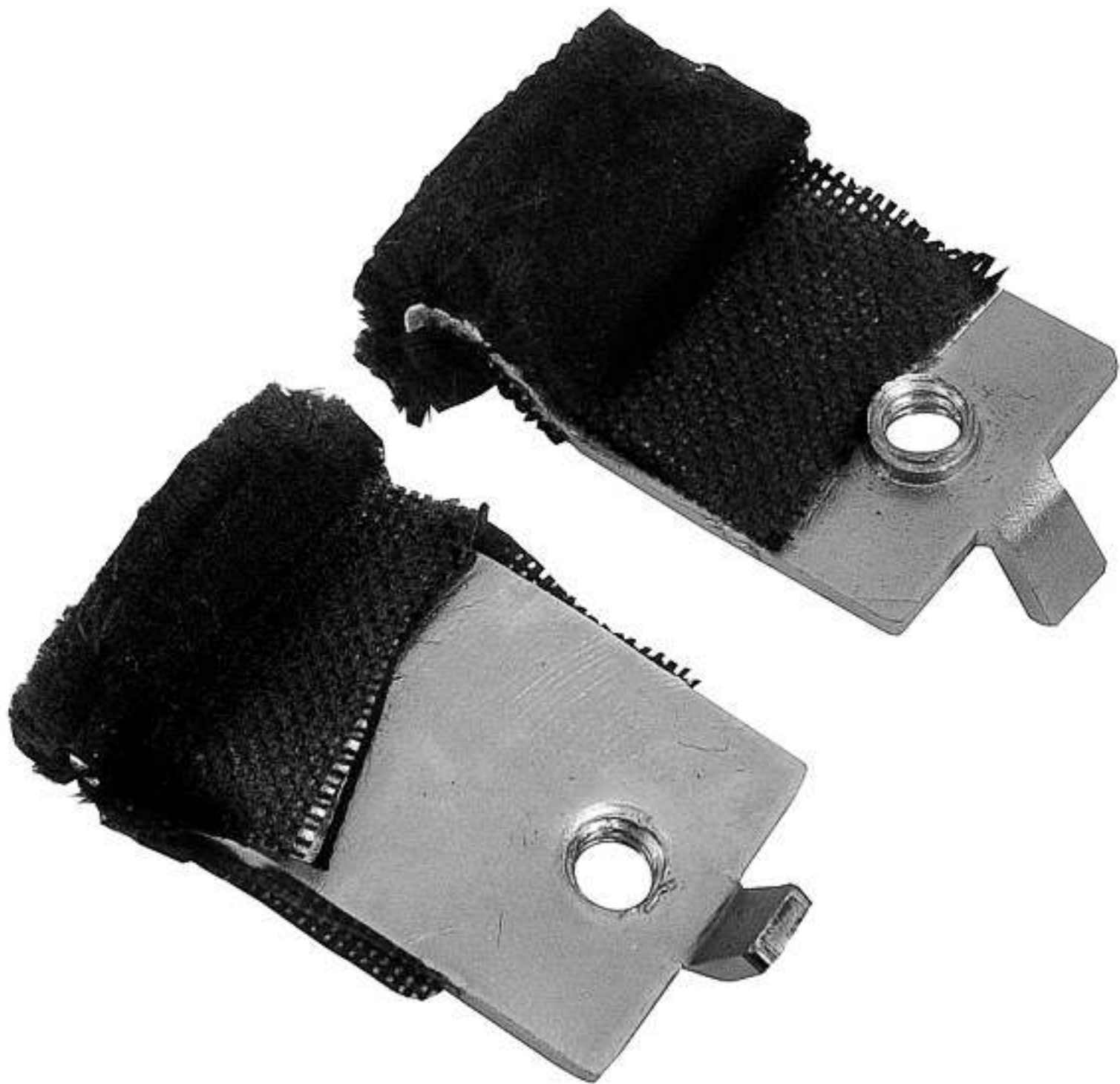











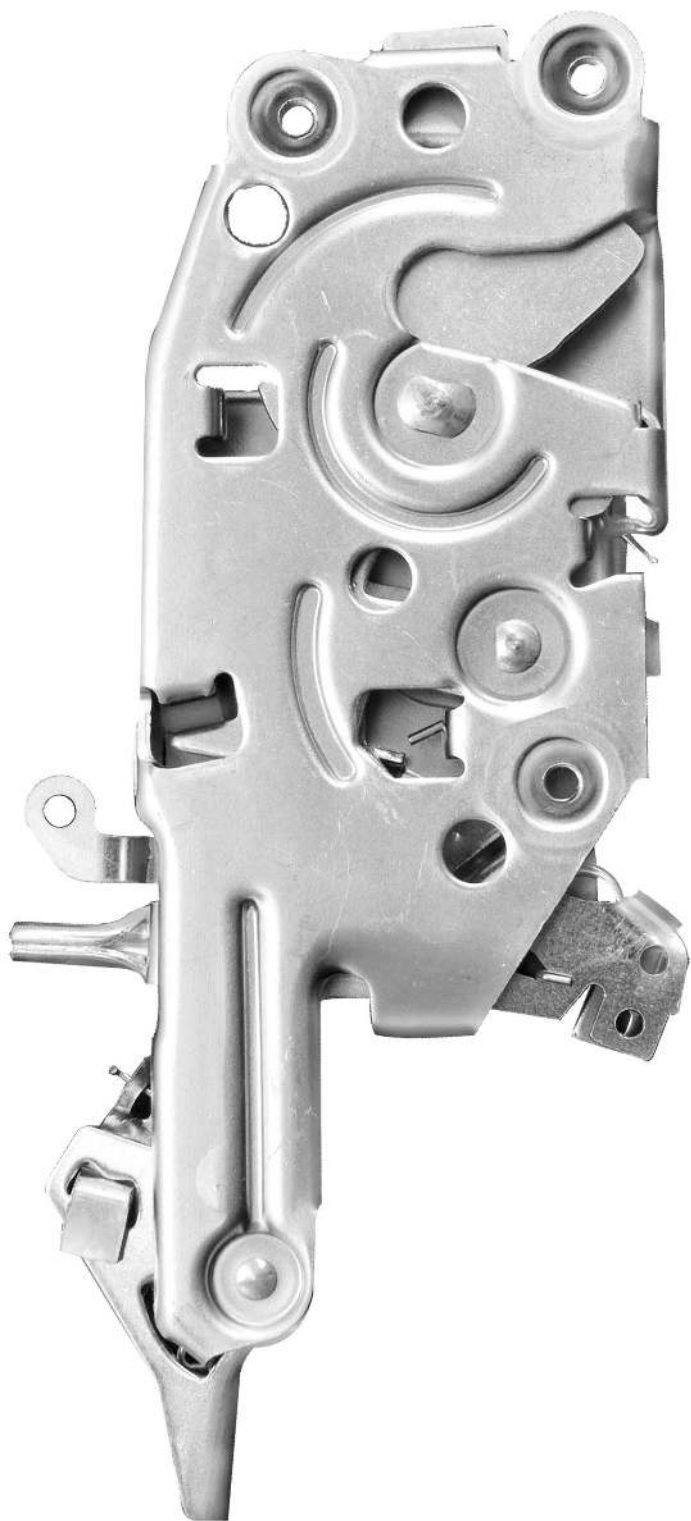

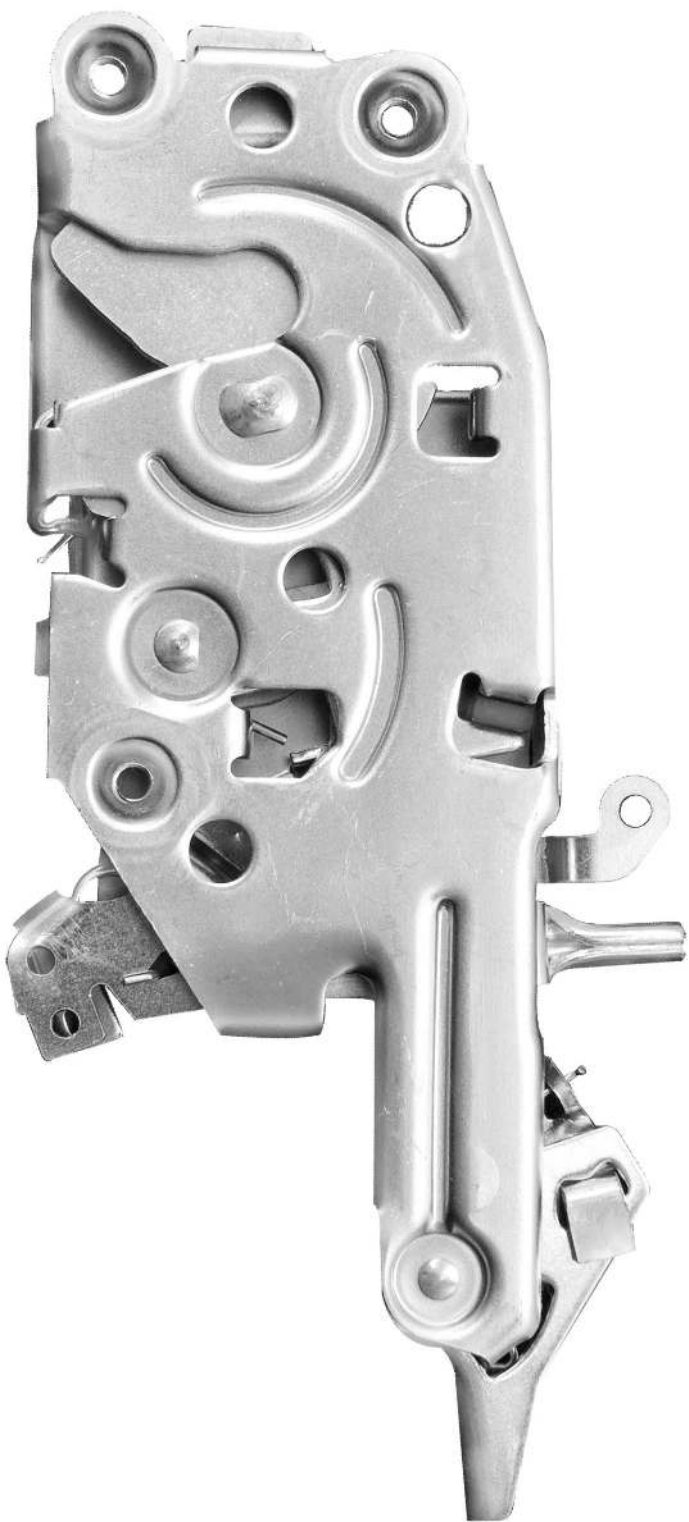







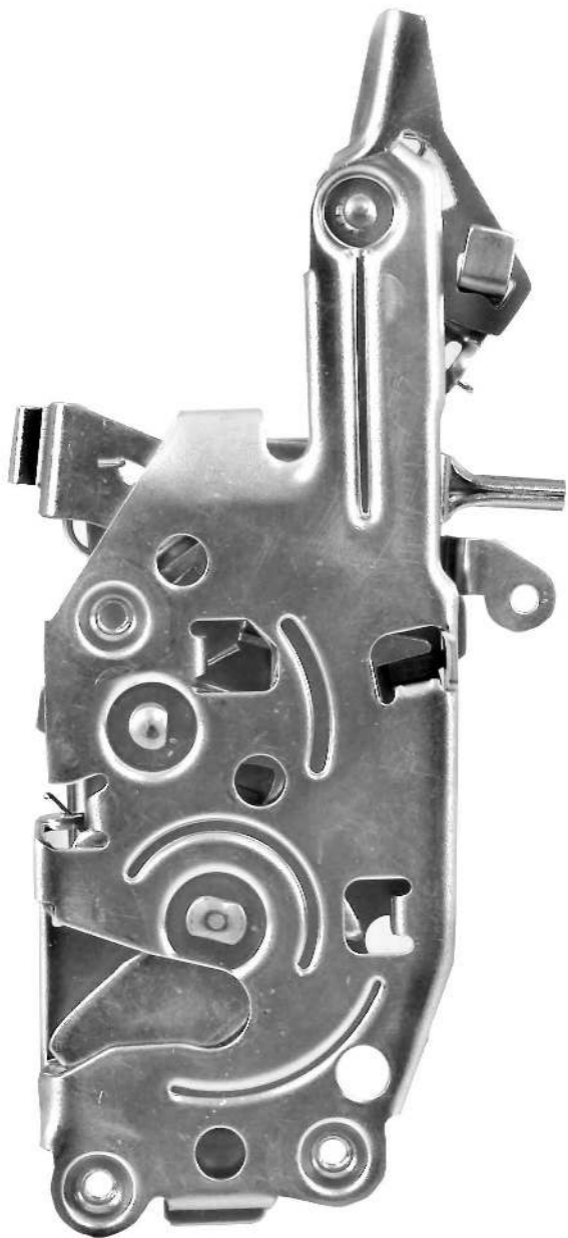









GH 1.12





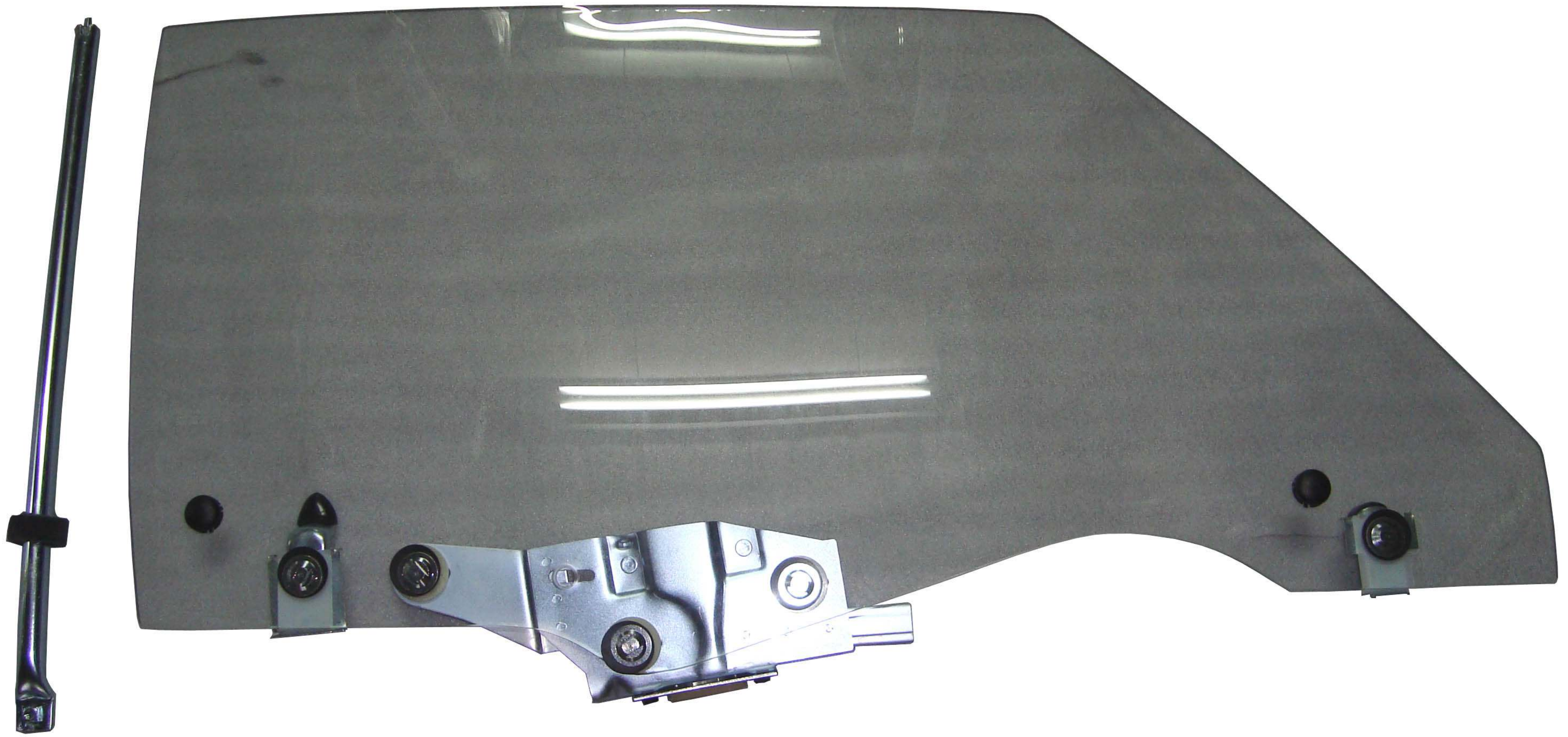





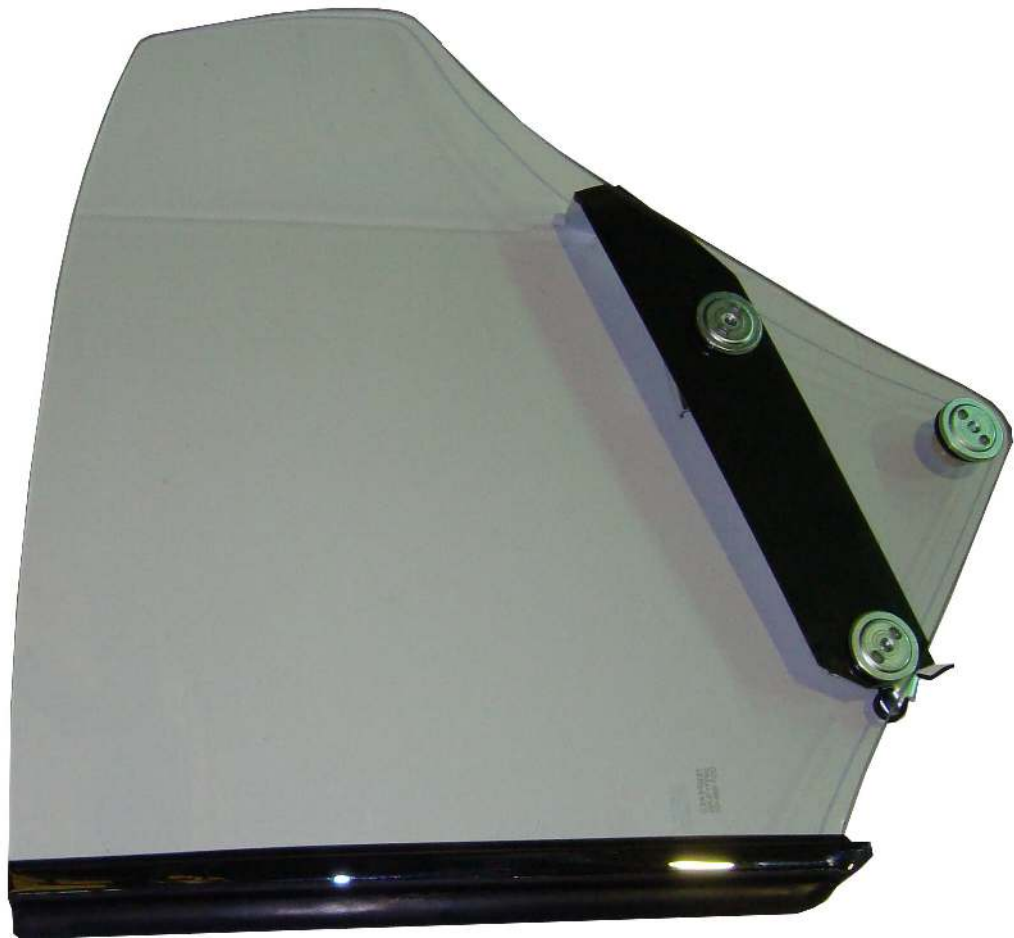

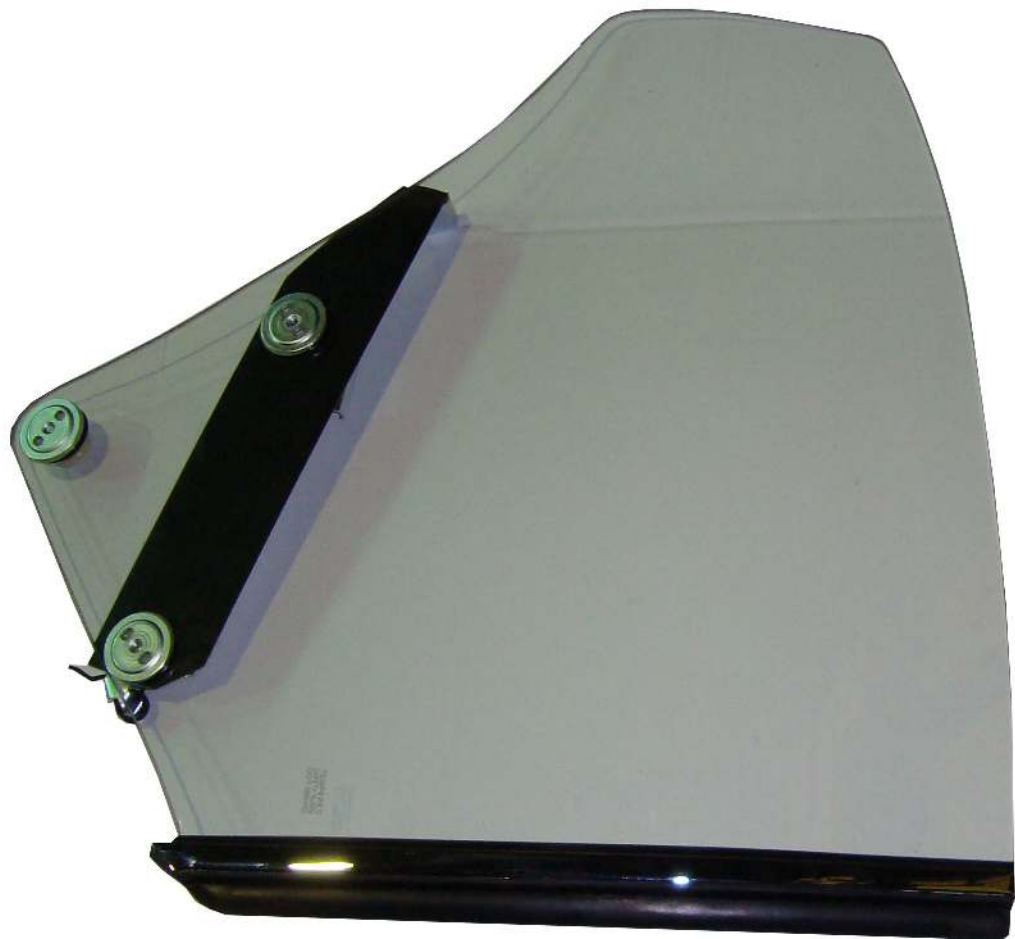







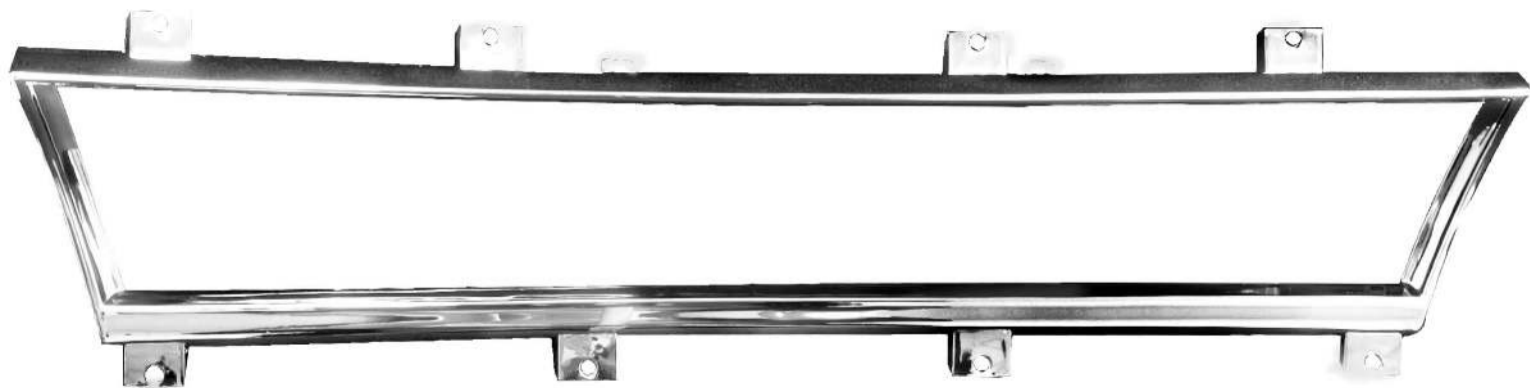

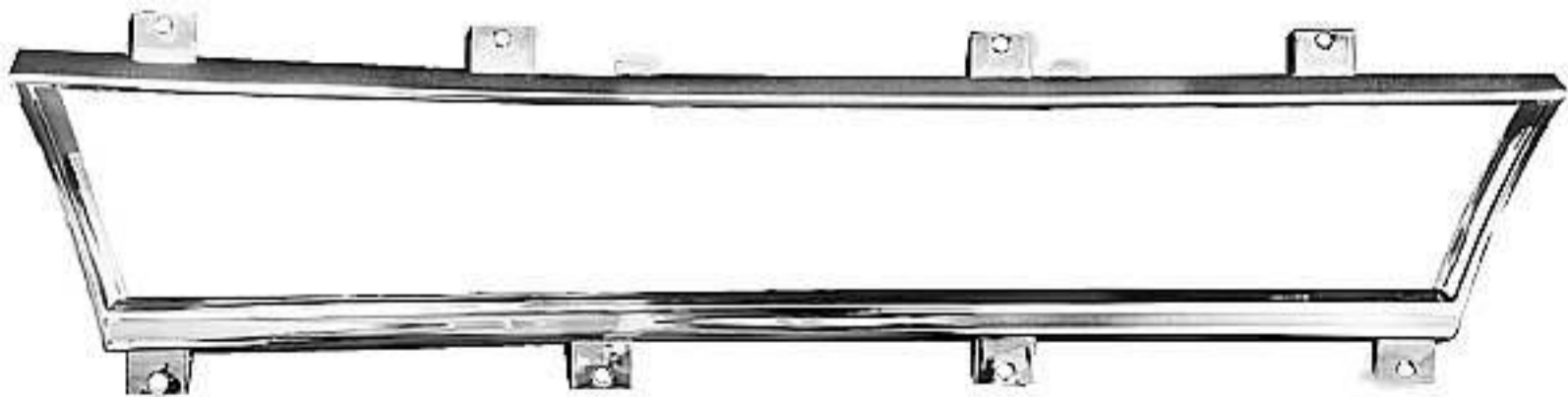





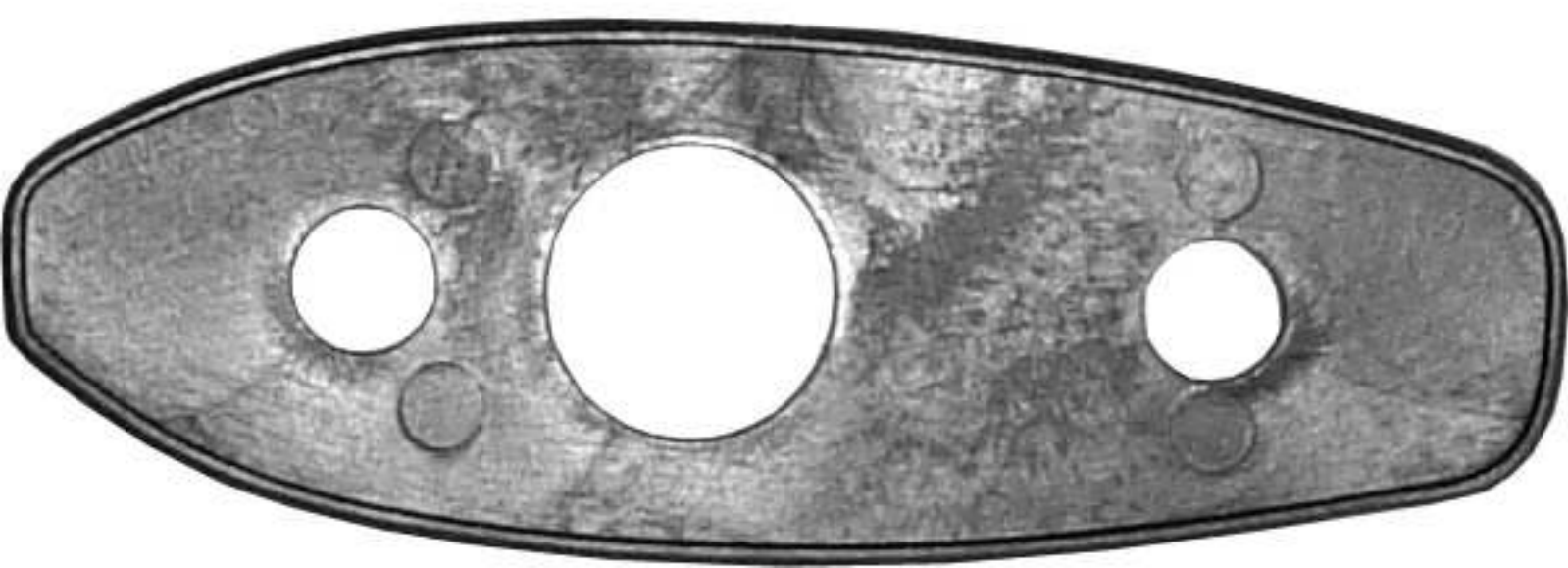
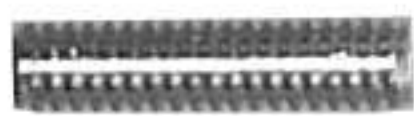

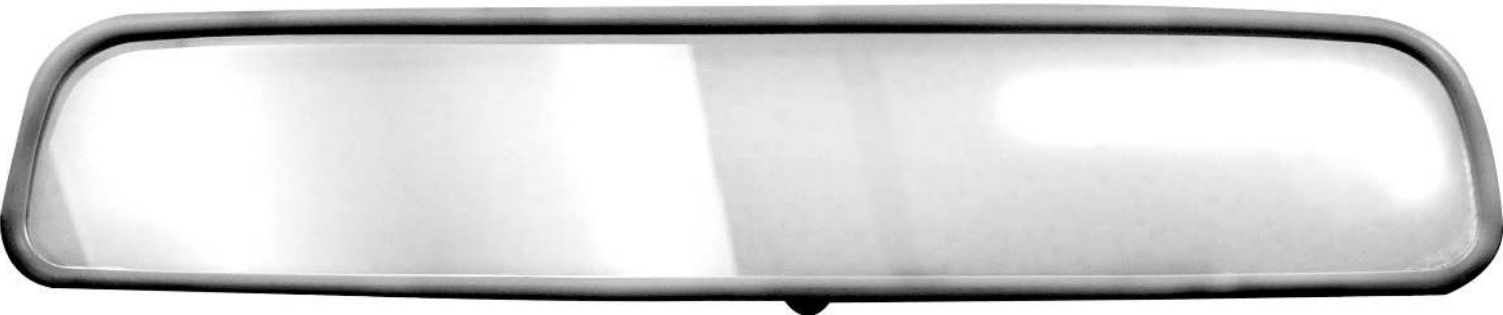





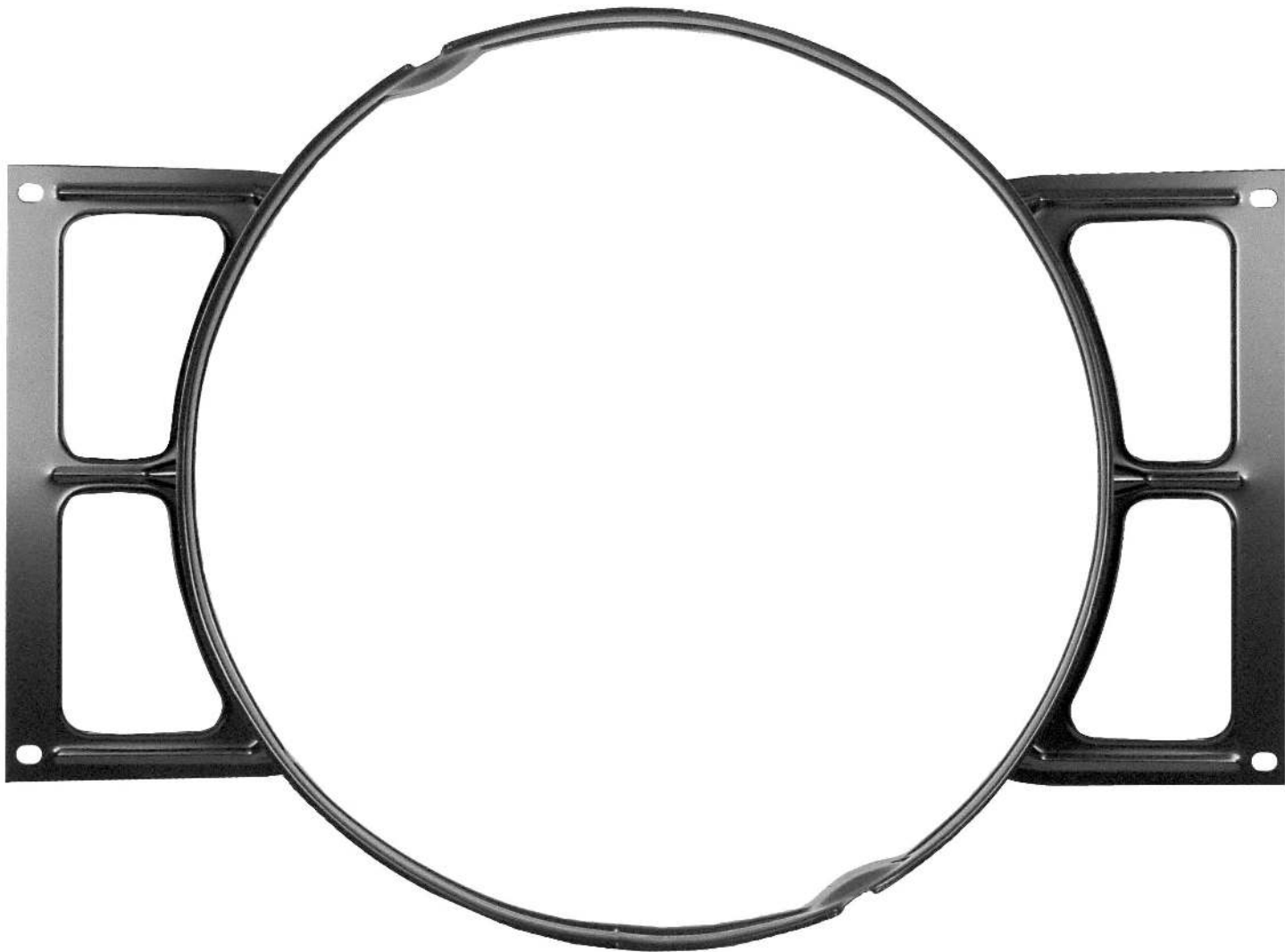







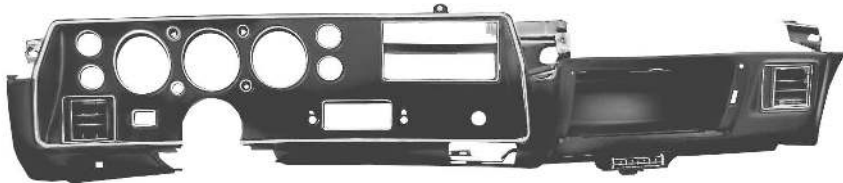

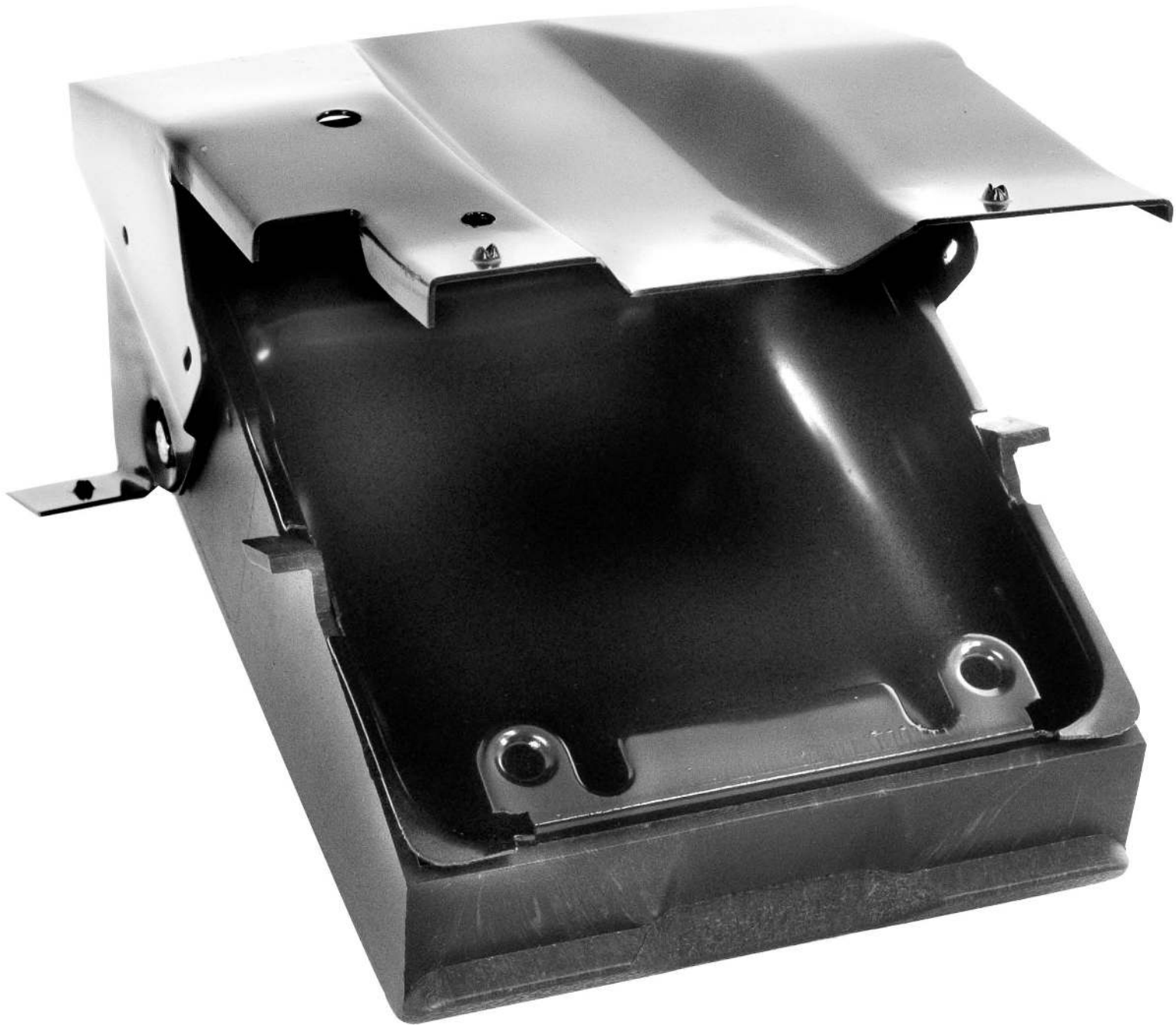

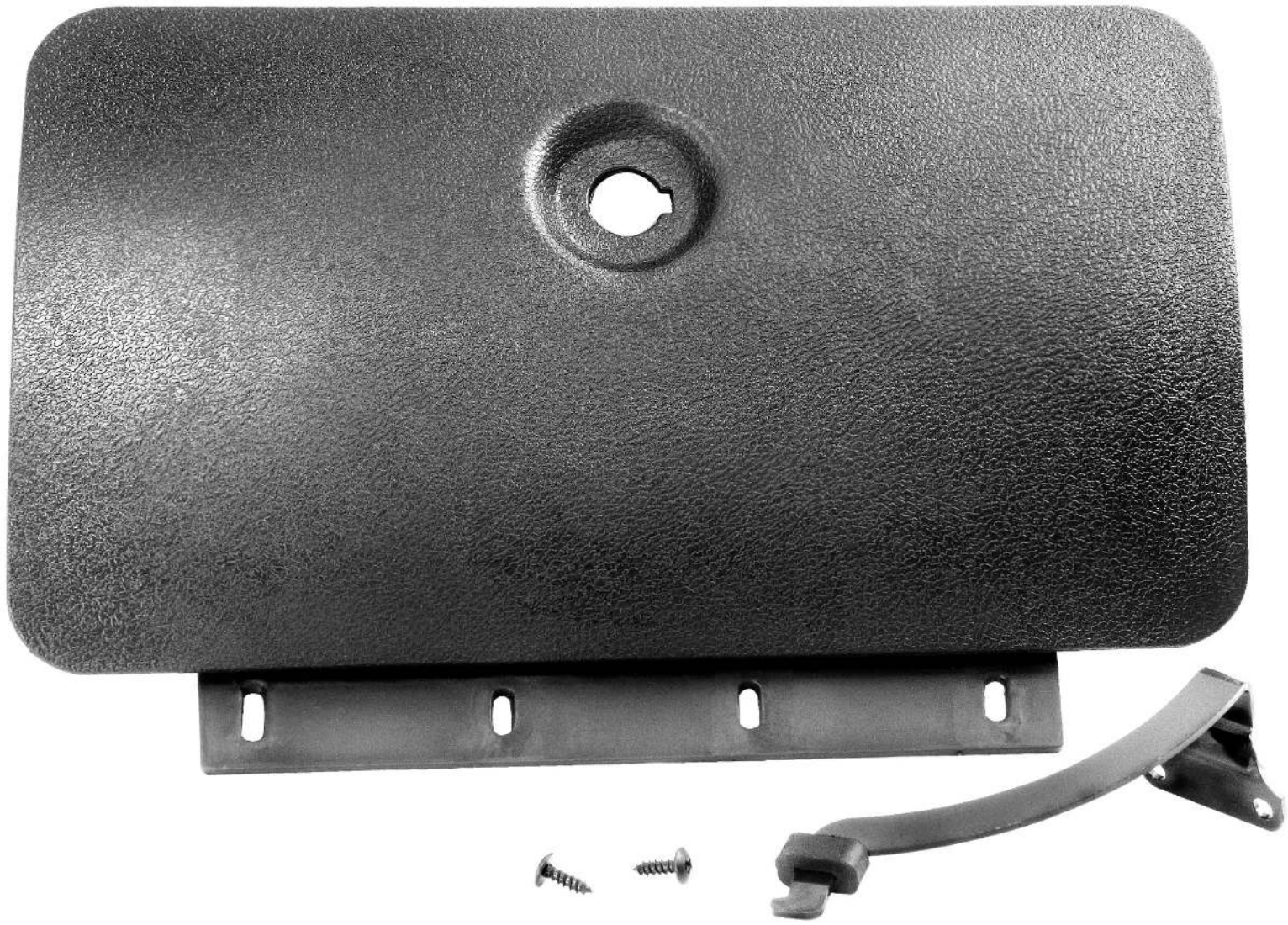



**FRONT
VIEW**



**REAR
VIEW**

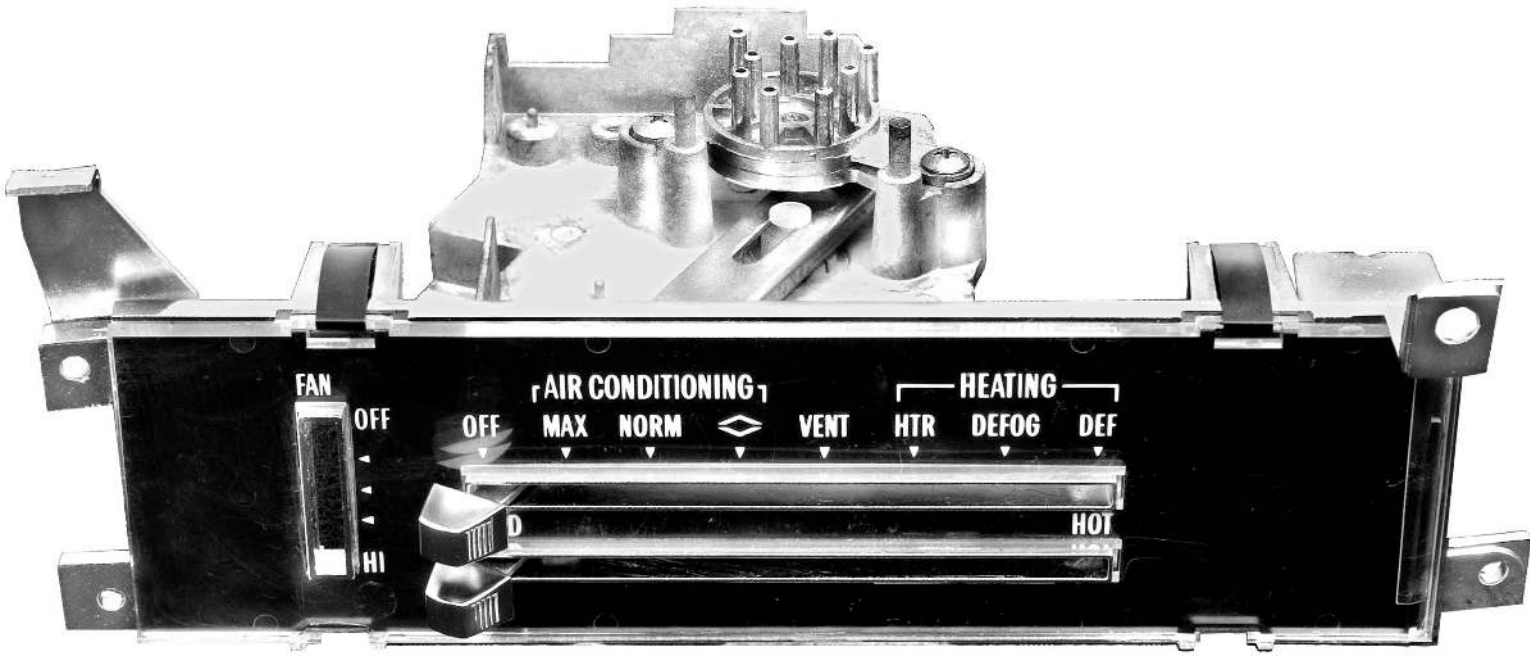

FAN

OFF



HI

AIR CONDITIONING

OFF

MAX

NORM



VENT

HEATING

HTR

DEFOG

DEF

D

HOT

























